

RICOH

FAX3900NF

Operating Instructions <Basic Features>

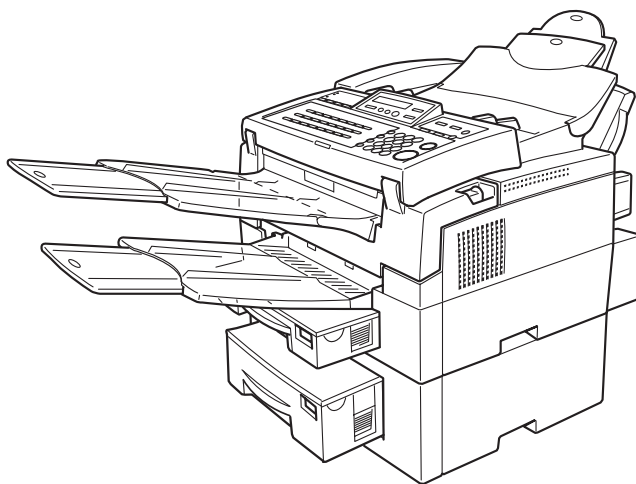

ZCKH030N

Read this manual carefully before you use this product and keep it handy for future reference.
For safety, please follow the instructions in this manual.



RICOH COMPANY, LTD.

15-5, Minami Aoyama 1-chome,
Minato-ku, Tokyo 107-8544, Japan
Phone: +81-(0)3-3479-3111

Ricoh shall not be responsible for any damage or expense that may result from the use of parts other than recommended parts.

For good copy quality, Ricoh recommends that you use genuine Ricoh toner.

TONER CASSETTES

RICOH FAX TONER CASSETTE TYPE 1135 BLACK(United States) is recommended for the best performance.
RICOH FAX TONER CASSETTE TYPE 1136 BLACK(Canada) is recommended for the best performance.

Overseas Affiliates

U.S.A.

RICOH CORPORATION
5 Dedrick Place
West Caldwell, New Jersey 07006
Phone: +1-973-882-2000

The Netherlands

RICOH EUROPE B.V.
Groenelaan 3, 1186 AA, Amstelveen
Phone: +31-(0)20-5474111

United Kingdom

RICOH UK LTD.
Ricoh House,
1 Plane Tree Crescent, Feltham,
Middlesex, TW13 7HG
Phone: +44-(0)20-8261-4000

Germany

RICOH DEUTSCHLAND GmbH
Mergenthalerallee 38-40,
65760 Eschborn
Phone: +49-(0)6196-9060

France

RICOH FRANCE S.A.
383, Avenue du Général de Gaulle
BP 307-92143 Clamart Cedex
Phone: +33-(0)1-40-94-38-38

Spain

RICOH ESPAÑA S.A.
Avda. Litoral Mar, 12-14,
08005 Barcelona
Phone: +34-(0)93-295-7600

Italy

RICOH ITALIA SpA
Via della Metallurgia 12,
37139 Verona
Phone: +39-045-8181500

Hong Kong

RICOH HONG KONG LTD.
21/F., Tai Yau Building,
181, Johnston Road,
Wan Chai, Hong Kong
Phone: +852-2862-2888

Singapore

RICOH ASIA PACIFIC PTE.LTD.
260 Orchard Road,
#15-01/02 The Heeren,
Singapore 238855
Phone: +65-830-5888

FAX3900NF Operating Instructions

Printed in China

UE (USA) H537-8600B

Introduction

This manual contains detailed instructions on the operation and maintenance of this machine. To get maximum versatility from this machine all operators should carefully read and follow the instructions in this manual. Please keep this manual in a handy place near the machine.

Please read the Safety Information in the Advanced Features manual before using this machine. It contains important information related to USER SAFETY and PREVENTING EQUIPMENT PROBLEMS.

Notes:

Some illustrations might be slightly different from your machine.

Certain options might not be available in some countries. For details, please contact your local dealer.

Laser Safety:

The Center for Devices and Radiological Health (CDRH) prohibits the repair of laser-based optical unit in the field. The optical housing unit can only be repaired in a factory or at a location with the requisite equipment. The laser subsystem is replaceable in the field by a qualified Customer Engineer. The laser chassis is not repairable in the field. Customer engineers are therefore directed to return all chassis and laser subsystems to the factory or service depot when replacement or the optical subsystem is required.

Operator Safety:

This machine is considered a CDRH Class I laser device, safe for office/EDP use. The machine contains a 5-milliwat, 765 - 805 nanometer wavelength, GaAIAs laser diode. Direct (or indirect reflected) eye contact with the laser beam may cause serious eye damage. Safety precautions and interlock mechanism have been designed to prevent any possible laser beam exposure to the operator.

Warning:

Use of controls or adjustment or performance of procedures other than those specified in this manual might result in hazardous radiation exposure.

Notes:

Two kinds of size notation are employed in this manual. With this machine refer to the inch version.

For good copy quality, Ricoh recommends that you use genuine Ricoh toner.

Ricoh shall not be responsible for any damage or expense that might result from the use of parts other than genuine Ricoh parts in your Ricoh office product.

Important

Parts of this manual are subject to change without prior notice. In no event will the company be liable for direct, indirect, special, incidental, or consequential damages as a result of handling or operating the machine.

Power Source:

AC120V, 60Hz

Please be sure to connect the power cord to a power source as above.

Declaration of Conformity

Product Name: Facsimile

Model Number: FAX3900NF

Responsible party: Ricoh Corporation

Address: 5 Dedrick Place, West Caldwell, NJ 07006

Telephone number: 973-882-2000

This device complies with part 15 of FCC Rules. Operation is subject to the following two conditions:

(1) This device may not cause harmful interference, and (2) this device must accept any interference received, including interference that may cause undesired operation.

USA**◆ FCC Requirements**

1. This equipment complies with Part 68 of the FCC rules. On the cover of this equipment is a label that contains, among other information, the FCC registration number and ringer equivalence number (REN) for this equipment. If requested, this information must be provided to the telephone company.
2. This equipment uses the following USOC jack: RJ11C
3. The REN is used to determine the quantity of devices which may be connected to the telephone line. Excessive REN's on the telephone line may result in the devices not ringing in response to an incoming call. In most, but not all areas, the sum of the REN's should not exceed five (5.0). Contact the telephone company to determine the maximum REN for the calling area.
4. If this equipment causes harm to the telephone network, the telephone company will notify you in advance that temporary discontinuance of service may be required. If advance notice is not practical, the telephone company will notify the customer as soon as possible. Also, you will be advised your right to file a complaint with the FCC if you believe it is necessary.
5. The telephone company may make changes in its facilities, equipment, operations, or procedures that could affect the operation of the equipment. If this happens, the telephone company will provide advance notice in order to make necessary modifications in order to maintain uninterrupted service.
6. In the event of operation problems (document jam, copy jam, communication error indication), refer to the solving problems section in this manual.
7. If you cannot correct the problem, please contact the RICOH CORP. CUSTOMER SUPPORT DEPT. at 1-800-FASTFIX for repair and warranty information. If it is causing harm to the telephone network, the telephone company may request you to disconnect the equipment from the network until the problem is resolved.
8. This equipment cannot be used telephone company-provided coin service. Connection to Party Line Service is subject to state tariffs.

◆ WHEN PROGRAMMING EMERGENCY NUMBERS AND/OR MAKING TEST CALLS TO EMERGENCY NUMBERS:

1. Remain on the line and briefly explain to the dispatcher the reason for the call before hanging up.
2. Perform such activities in the off-peak hours, such as early morning hours or late evenings.

CANADA

The Industry Canada label identifies certified equipment. This certification means that the equipment meets telecommunications network protective, operational, and safety requirements as prescribed in the appropriate Terminal Equipment Technical Requirements document(s). The department does not guarantee the equipment will operate to the user's satisfaction.

Before installing this equipment, users should ensure that it is permissible to be connected to the facilities of the local telecommunications company. The equipment must also be installed using an acceptable method of connection. The customer should be aware that compliance with the above conditions may not prevent degradation of service in some situations.

Repairs to certified equipment should be coordinated by a representative designated by the supplier. Any repairs or alterations made by the user to this equipment, or equipment malfunctions, may give the telecommunications company cause to request the user disconnect the equipment.

User should ensure for their own protection that the electrical ground connections of the power utility, telephone lines, and internal metallic water pipe system, if present, are connected together. This precaution may be particularly important in rural areas.

Caution: Users should not attempt to make such connections themselves, but should contact the appropriate electric inspection authority, or electrician, as appropriate.

The Ringer Equivalence Number (REN) assigned to each terminal device provides an indication of the maximum number of terminals allowed to be connected to a telephone interface. The termination on an interface may consist of any combination of device subject only to the requirement that the sum of the Ringer Equivalence Numbers of all the devices does not exceed 5.

In accordance with IEC 60417, this machine uses the following symbols for the main power switch:

- means POWER ON.
- means POWER OFF.

Introduction

This manual contains detailed instructions on the operation and maintenance of this machine. To get maximum versatility from this machine all operators should carefully read and follow the instructions in this manual. Please keep this manual in a handy place near the machine.

Please read the Safety Information in the Advanced Features manual before using this machine. It contains important information related to USER SAFETY and PREVENTING EQUIPMENT PROBLEMS.

Notes:

Some illustrations might be slightly different from your machine.

Certain options might not be available in some countries. For details, please contact your local dealer.

Laser Safety:

The Center for Devices and Radiological Health (CDRH) prohibits the repair of laser-based optical unit in the field. The optical housing unit can only be repaired in a factory or at a location with the requisite equipment. The laser subsystem is replaceable in the field by a qualified Customer Engineer. The laser chassis is not repairable in the field. Customer engineers are therefore directed to return all chassis and laser subsystems to the factory or service depot when replacement or the optical subsystem is required.

Operator Safety:

This machine is considered a CDRH Class I laser device, safe for office/EDP use. The machine contains a 5-milliwatt, 765 - 805 nanometer wavelength, GaAlAs laser diode. Direct (or indirect reflected) eye contact with the laser beam may cause serious eye damage. Safety precautions and interlock mechanism have been designed to prevent any possible laser beam exposure to the operator.

Warning:

Use of controls or adjustment or performance of procedures other than those specified in this manual might result in hazardous radiation exposure.

Notes:

Two kinds of size notation are employed in this manual. With this machine refer to the inch version.

For good copy quality, Savin recommends that you use genuine toner.

Savin shall not be responsible for any damage or expense that might result from the use of parts other than genuine parts in your office product.

Important

Parts of this manual are subject to change without prior notice. In no event will the company be liable for direct, indirect, special, incidental, or consequential damages as a result of handling or operating the machine.

Power Source:

AC120V, 60Hz

Please be sure to connect the power cord to a power source as above.

Declaration of Conformity

Product Name: Facsimile

Model Number: 3740nf/9940nf

Responsible party: SAVIN CORPORATION

Address: 333 Ludlow Street, Stamford, CT 06904

Telephone number: 203-967-5000

This device complies with part 15 of FCC Rules. Operation is subject to the following two conditions:

(1) This device may not cause harmful interference, and (2) this device must accept any interference received, including interference that may cause undesired operation.

USA**◆ FCC Requirements**

1. This equipment complies with Part 68 of the FCC rules. On the cover of this equipment is a label that contains, among other information, the FCC registration number and ringer equivalence number (REN) for this equipment. If requested, this information must be provided to the telephone company.
2. This equipment uses the following USOC jack: RJ11C
3. The REN is used to determine the quantity of devices which may be connected to the telephone line. Excessive REN's on the telephone line may result in the devices not ringing in response to an incoming call. In most, but not all areas, the sum of the REN's should not exceed five (5.0). Contact the telephone company to determine the maximum REN for the calling area.
4. If this equipment causes harm to the telephone network, the telephone company will notify you in advance that temporary discontinuance of service may be required. If advance notice is not practical, the telephone company will notify the customer as soon as possible. Also, you will be advised your right to file a complaint with the FCC if you believe it is necessary.
5. The telephone company may make changes in its facilities, equipment, operations, or procedures that could affect the operation of the equipment. If this happens, the telephone company will provide advance notice in order to make necessary modifications in order to maintain uninterrupted service.
6. In the event of operation problems (document jam, copy jam, communication error indication), refer to the solving problems section in this manual.
7. If you cannot correct the problem, please contact the SAVIN CORPORATION at 1-203-967-5000 for repair and warranty information. If it is causing harm to the telephone network, the telephone company may request you to disconnect the equipment from the network until the problem is resolved.
8. This equipment cannot be used telephone company-provided coin service. Connection to Party Line Service is subject to state tariffs.

◆ WHEN PROGRAMMING EMERGENCY NUMBERS AND/OR MAKING TEST CALLS TO EMERGENCY NUMBERS:

1. Remain on the line and briefly explain to the dispatcher the reason for the call before hanging up.
2. Perform such activities in the off-peak hours, such as early morning hours or late evenings.

CANADA

The Industry Canada label identifies certified equipment. This certification means that the equipment meets telecommunications network protective, operational, and safety requirements as prescribed in the appropriate Terminal Equipment Technical Requirements document(s). The department does not guarantee the equipment will operate to the user's satisfaction.

Before installing this equipment, users should ensure that it is permissible to be connected to the facilities of the local telecommunications company. The equipment must also be installed using an acceptable method of connection. The customer should be aware that compliance with the above conditions may not prevent degradation of service in some situations.

Repairs to certified equipment should be coordinated by a representative designated by the supplier. Any repairs or alterations made by the user to this equipment, or equipment malfunctions, may give the telecommunications company cause to request the user disconnect the equipment.

User should ensure for their own protection that the electrical ground connections of the power utility, telephone lines, and internal metallic water pipe system, if present, are connected together. This precaution may be particularly important in rural areas.

Caution: Users should not attempt to make such connections themselves, but should contact the appropriate electric inspection authority, or electrician, as appropriate.

The Ringer Equivalence Number (REN) assigned to each terminal device provides an indication of the maximum number of terminals allowed to be connected to a telephone interface. The termination on an interface may consist of any combination of device subject only to the requirement that the sum of the Ringer Equivalence Numbers of all the devices does not exceed 5.

In accordance with IEC 60417, this machine uses the following symbols for the main power switch:

- I** means **POWER ON**.
- means **POWER OFF**.

How to Read this Manual

How to Read this Manual

Symbols

In this manual, the following symbols are used:

 **WARNING:**

This symbol indicates a potentially hazardous situation that might result in death or serious injury when you misuse the machine without following the instructions under this symbol. Be sure to read the instructions, all of which are described in the Safety Information section in the Advanced Features manual.

 **CAUTION:**

This symbol indicates a potentially hazardous situation that might result in minor or moderate injury or property damage that does not involve personal injury when you misuse the machine without following the instructions under this symbol. Be sure to read the instructions, all of which are described in the Safety Information section in the Advanced Features manual.

* The statements above are notes for your safety.

 **Important**

If this instruction is not followed, paper might be misfed, originals might be damaged, or data might be lost. Be sure to read this.

 **Preparation**

This symbol indicates the prior knowledge or preparations required before operating.

 **Note**

This symbol indicates precautions for operation, or actions to take after misoperation.

 **Limitation**

This symbol indicates numerical limits, functions that cannot be used together, or conditions in which a particular function cannot be used.

 **Reference**

This symbol indicates a reference.

[]

Keys built into the machine's operation panel.

TABLE OF CONTENTS

Manuals for this machine	1
Basic Features (This Manual)	1
Advanced Features	1
1. Introduction	
<hr/>	
Part Names	3
Operation Panel	5
Symbols and Conventions Used in This Manual.....	8
2. Faxing	
<hr/>	
Transmission Modes.....	9
Suitable Document Types.....	10
Memory Transmission and Immediate Transmission.....	11
Memory Transmission.....	11
Canceling a Memory Transmission.....	13
Immediate Transmission	14
Canceling an Immediate Transmission	15
Very Fine Detail Faxing	16
Resolution	16
Dialing.....	17
Entering Numbers Directly	17
Entering Pauses	18
Switching to Tone Signals.....	18
Using Quick Dial.....	18
Using Speed Dial	19
Using Groups	20
Reception Modes.....	22
How to Select the Reception Mode	22

3. Setup

Initial Settings and Adjustments.....	23
Initial Settings.....	24
Storing and Editing Fax Numbers.....	27
Storing Quick Dial Numbers.....	27
Editing Quick Dial Numbers.....	29
Deleting Quick Dial Numbers.....	30
Printing a Quick Dial Key Label.....	31
Quick Dial Key Labels.....	32
Storing Speed Dial Numbers.....	33
Editing Speed Dial Numbers.....	34
Deleting Speed Dial Numbers.....	36
Storing and Editing a Group of Fax Numbers	37
Storing a Group of Fax Numbers.....	37
Editing a Group.....	40
Deleting a Group.....	43
Entering Characters	46
Entering Symbols.....	46
Wild Card.....	46

4. Troubleshooting

Loading Paper in the Main Paper Cassette.....	49
Adjusting the Volume and Sounds the Machine Makes	51
If an Indicator Lights on the Operation Panel.....	53
Communication Problems.....	54
Clearing a Document Jam	55
Clearing a Copy, Fax, or Print Jam.....	56
Print Delivery Tray.....	56
Inside the Machine.....	56
Cassette Entrance.....	57
Upper Rear Unit.....	58
Error Messages.....	60
Solutions to Common Problems.....	62

5. Appendix

Options.....	67
INDEX.....	68

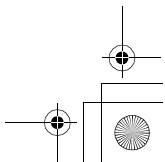
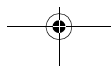
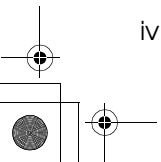
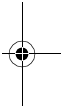
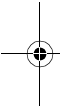
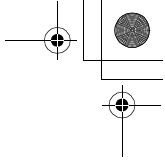
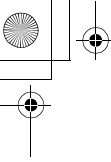

Manuals for this machine

This machine is provided with a Basic Features manual and an Advanced Features manual. Please consult the manual that suits your needs.

Basic Features (This Manual)

The Basic Features manual explains the most frequently used fax functions and operations.

Advanced Features

The Advanced Features manual describes more advanced functions, and also explains settings for key operators.

❖ Chapter 1 Transmission Options

Explains transmission features such as scheduling transmission for a specific time, setting personal codes, sending confidential documents; and storing documents for pick-up by polling transmission.

❖ Chapter 2 Communication Information

Explains how to obtain information about stored documents, confidential documents, and memory-locked documents; explains how to print the Journal.

❖ Chapter 3 Other Transmission Features

Discusses special dialing features, switching between G3 and G4 communication; and explains advanced transmission features such as broadcasting and batch transmission.

❖ Chapter 4 Reception Features

Explains various reception features. You can find out about receiving documents in telephone mode, and printing two pages of received documents on one page.

❖ Chapter 5 Copying

Read this chapter when you would like to know about copying operations and functions.

❖ Chapter 6 Facsimile User Tools

Explains about programming frequently used functions for Quick Dial Key and User Function Key.

❖ Chapter 7 Key Operator Settings

Explains a variety of settings that can be made by the fax machine's key operator to control and monitor usage of the machine. You can find out about setting up the phone line type, and how to store the Memory Locked ID and the Confidential ID.

◆ **Chapter 8 Troubleshooting**

Discusses troubleshooting topics such as printing the help list, clearing jams, and reading reports.

◆ **Chapter 9 Maintaining Your Machine**

Explains about loading paper in the optional bypass feeder, cleaning the rollers and scanner and so on.

◆ **Chapter 10 Installation**

Explains installation considerations, connection to a telephone line, and connecting the power.

◆ **Chapter 11 Appendix**

Lists specifications and the machine's advanced communication features.

1. Introduction

Part Names

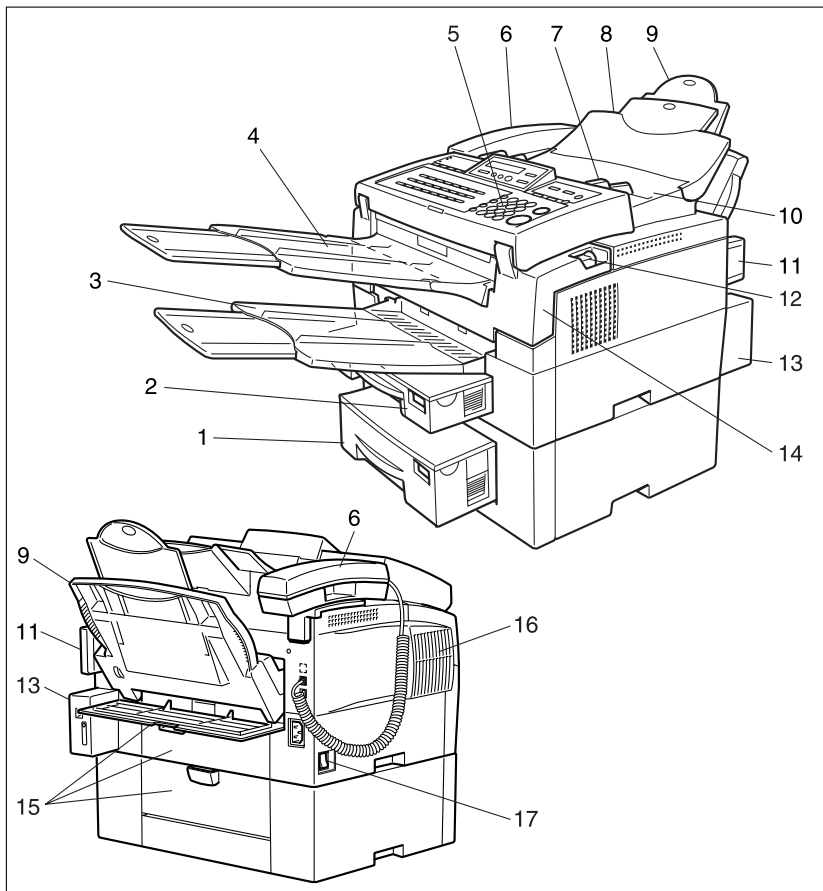

ZCKH010N

1. Optional Second Paper Cassette

The optional second paper cassette holds more paper.

2. Main Paper Cassette

The main paper cassette holds copy paper.

3. Print Delivery Tray

Copies, incoming faxes, and prints are delivered here. The tray can be extended for large paper sizes.

4. Document Delivery Tray

Scanned documents are stacked on the document delivery tray.

Introduction

5. Operation Panel

Key panel for operating the machine.

6. Optional Handset

7. Document Guide

Match the document guide to the size of your original documents.

8. Document Table

Document table holds up to 50 sheets which are fed one at a time. Place your original documents here.

9. Optional Bypass Feeder

Expands paper delivery capability to handle A4, Legal and F4 sizes.

10. Auto Document Feeder (ADF)

Set multi-page documents here to have them automatically scanned in one page at a time.

11. Memory Card Cover

Protects the machines optional memory card.

12. Front Cover Release Lever

Pull this lever to release the front cover.

13. G4 Interface Unit

Allows the fax machine to be connected for G4 (ISDN) communication.

14. Front Cover

15. Rear Covers

16. Ventilation Port

Provides ventilation for internal parts of the machine in order to prevent overheating.

17. Main Switch

The main switch turns your machine on and off.

1

4

Operation Panel

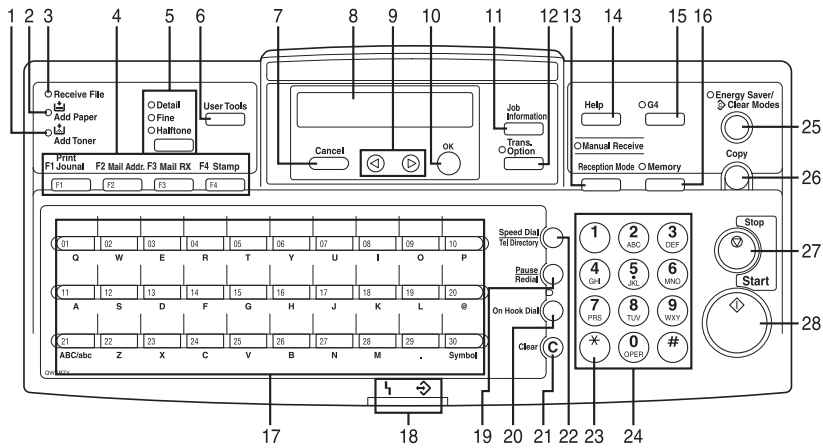

ZCK5012N

1. Add Toner indicator

Blinks when toner is about to run out and lights continuously when toner has run out.

2. Add Paper indicator

Lights when a cassette is empty or the paper cassette is not fully inserted.

3. Receive File indicator

Lights when an incoming document is received into memory, and flashes when confidential or memory-locked document is received. (See P.53 "If an Indicator Lights on the Operation Panel").

4. User Function keys

There are four User Function keys.

Four User Function keys are provided to store frequently used functions and operations.

The following functions are registered by default:

Key	Function
F1	Prints a transmission management report.
F2	Initiates entry of an E-mail address.
F3	Immediately checks for and receives any incoming E-mail.
F4	Switches stamping off/on.

5. [Resolution] key

Selects the scanning resolution or the halftone scanning mode. When the Detail mode, Fine mode, or Halftone mode is selected, the corresponding indicator lights. Standard mode is selected when no indicator is lit.

The Detail and Fine modes offer progressively higher scanning resolutions. The Halftone mode is used for faxing photographs or drawings that contain halftones.

1

5

6. [User Tools] key

Press to access User Tool Settings and customize various functions.

7. [Cancel] key

Press when you want to cancel an operation or return to the previous display.

8. Control panel display

Guides you through tasks and informs you of the status of the machine. Messages appear here.

9. Scroll Keys

Use these keys to move the cursor in the display, or to change the display.

10. [OK] key

Press to answer "Yes" to a question displayed on the display.

11. [Job Information] key

Press to search for information on a specific job.

12. [Trans. Option] key

Press to change the transmission option settings. The indicator lights when option settings are changed.

13. [Reception Mode] key

Press to select the reception mode. When the Manual Receive indicator is on, Manual Receive is selected.

14. [Help] key

Press the Help key when you want to print a help list.

15. [G4] key

When the optional G4 unit is installed, press to select G3 or G4 mode. When the indicator is lit, G4 is selected.

16. [Memory] key

Press to select Immediate Transmission. When the Memory indicator is not lit, Immediate Transmission is selected, and when the indicator is lit, Memory Transmission is selected.

17. [Quick Dial] keys



There are 30 Quick Dial keys. Use them to store individual fax numbers (see P.27 "Storing and Editing Fax Numbers"), or to enter characters (see P.46 "Entering Characters"). In addition, you can use the Quick Dial keys to register functions such as groups, programs, and auto documents.

You can select either a QWERTY key board layout (as shown in the illustration) or an ABC layout. See Chapter 7, "Key Layout" in the Advanced Features manual.

When attaching the Quick Dial label, make sure you remove the Quick Dial cover (transparent).

18. Status Indicators

These indicators keep you informed about the current status of the unit.

-  Alarm
When the alarm indicator flashes, check the display and read the message to identify a problem (such as paper jam or open cover).
-  Communicating
Lights during fax transmission or reception.



19. [Pause/Redial] key

Inserts a pause when you are dialing or storing a fax number, or redials the last number dialed when pressed by itself. (The redial feature does not work once you have started dialing a new number.)

20. [On Hook Dial] key

Press to dial a phone call from the keypad without lifting the external telephone or taking the handset off the hook (if the machine is equipped with the optional telephone or handset).

21. [Clear] key

Press to delete the last character or digit entered, or press  or  to move the cursor, and then press the [Clear] key to delete whatever is at the cursor.

22. [Speed Dial/Tel Directory] key

Press when you want to use the Speed Dial or Telephone Directory feature.

23. [✳] (Tone) key

If your telephone line uses pulse dialing, press this button to switch temporarily to tone dialing if you want to use telephone services that utilize telephone touch tones.

24. Number keys

Use the number keys to dial fax numbers, to enter the number of copies, and so forth.

25. [Energy Saver/↻ Clear Modes] key

Energy Saver: Hold down for 2 seconds to select or deselect energy saver mode. When the machine is not used or no data is received for a fixed period, the machine goes into energy saver mode automatically.

Clear Modes: Press to clear any selected settings and return the machine to its previous condition.

26. [Copy] key

Press to copy the document currently loaded in the feeder.

27. [Stop] key

Stops transmissions or document scanning, reception, and long copy runs. The machine finishes printing out the current page, then stops.

28. [Start] key

Press to start transmission, copy operation, or output of reports.

Symbols and Conventions Used in This Manual

1

◆ Documents:

A document is anything you put on the document table of your machine, whether you are faxing it or copying it.

◆ Prints:

A print is anything that comes out of the machine, whether: a received fax or a copy you made.

◆ Procedures:

Procedures are described step by step. Perform them in order. When you see a display, it always shows what comes after performing the step it accompanies. Other illustrations accompanying steps help you find the right key or handle, or show you how to perform the step.

■ This is a step in a procedure.

THIS CORRESPONDS TO
THE PANEL DISPLAY.

2. Faxing

Transmission Modes

There are two types of transmission.

◆ Memory Transmission

When a fax document is stored in memory, then transmission starts automatically.

It is convenient when you would like to take documents back in a hurry.

You can send the same message to more than one destination in a single operation. This technique is referred to as Broadcasting.

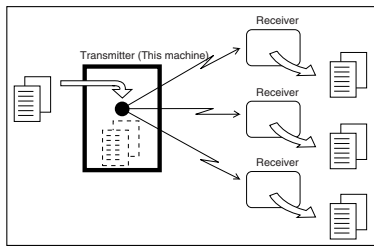

◆ Immediate Transmission

The machine dials immediately, and transmits the fax while scanning.

It is convenient when you would like to send a document immediately, and would like to check whether you have successfully connected with the other party's fax machine.

A fax document is not stored in memory.

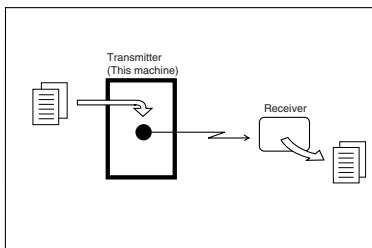

⚠ Important

- ❑ If there is a power failure, the power switch is turned off, or the plug is pulled out for more than 1 hour, all documents stored in memory are deleted. As soon as power is restored, the Power Failure Report is printed to help you identify deleted documents. See Chapter 8 "Power Failure Report" in the Advanced Features manual.

✎ Note

- ❑ Using the Internet Fax feature of your fax machine, you can also scan documents and send them over the Internet as E-mail, as well as receive document images sent as E-mail by another Internet Fax machine or PC. See the NIC FAX KIT manual for details.

Suitable Document Types

2

Never load damaged originals in the ADF (Auto Document Feeder) for scanning. Always check the stack of originals before loading.

- Always check the sheets and remove staples, pins, paper clips, or any other type of fasteners.
- If the sheets are curled or folded, flatten them.
- Separate all the sheets to ensure that they will not jam or double feed during scanning.
- If the sheets are heavily creased, torn, punched with holes for binding, or patched together with tape, make copies and then load the copies in the ADF.
- Before loading a stack of originals, make sure that they are all the same size. Do not mix sheets of different sizes.
- Before loading a stack of originals, always fan them to remove static cling.
- To protect fragile or legal documents from damage due to document jams, copy such documents and then load the copies for scanning.

Important

- Never place the following types of originals in the ADF:
 - Sheets marked with crayon, paint, charcoal, or soft pencil.
 - Sheets pasted up with tape or glue.
 - Specially treated paper, including thermal paper, OHP sheets, vinyl sheets or film, waxed paper, carbon paper, deed paper, or paper treated with silicone oil.
 - Paper that is not perfectly dry. If documents have ink or correction fluid that is still wet, all them to dry thoroughly before loading them into the ADF.

Memory Transmission and Immediate Transmission

Memory Transmission

Memory Transmission is convenient because:

- Fax documents can be scanned much more quickly. Your scanned document is stored in the memory, and then sent automatically, meaning you do not have to wait for your document to send.
- While your fax document is being sent, another user can operate the machine (people do not have to wait long to use the fax machine).
- You can send the same document to more than one place with the same operation.
- There are two kinds of Memory Transmission: Parallel and Normal. Parallel Memory Transmission is the default. See Chapter 3, "Parallel Memory Transmission" in the Advanced Features manual.

Limitation

- If 0% is displayed, you cannot perform Memory Transmission. Send your document using Immediate Transmission.

Note

- If your document jams while it is being scanned, press the **[Stop]** key, and then refer to P.55 "Clearing a Document Jam" for instructions on how to safely remove the original.

Reference

See Chapter 2, "Transmission" in the NIC FAX KIT manual for how to scan and send documents as E-mail.

- 1 Make sure that the machine is in standby mode.**

The display should look like this:

```
Ready 100% 02:39PM
Set Orig./ Enter NO.
```

Note

- If the display is blank, press the **[Energy Saver]** key to exit Energy Saving mode.

- 2 Fan your document stack (maximum: 50 pages, 20 lb) to make sure all pages are loose, and then tap the edges to square the stack.**

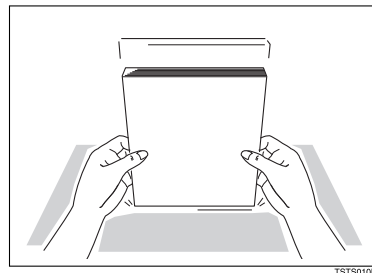

Limitation

- All pages set in the feeder must be of the same size.

Faxing

3 Insert the document facedown into the feeder until the machine beeps. Then adjust the guides to match the width of the document.

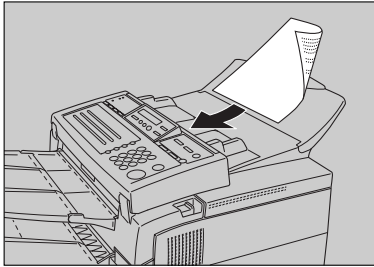

ZCKY010N

Note

- You can dial before you set the document. Place the document after you dial the number and go to step **7**.
- Set your document straight in the feeder. If you set more than 15 sheets, make sure the leading ends of the documents are even.

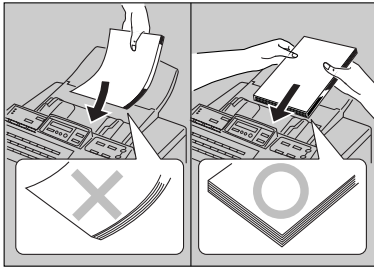

ZCKY900N

4 The display will look like this:

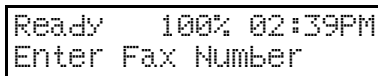

5 If the memory indicator is not lit, press the **[Memory]** key.

6 Dial the number in one of the following ways.



Number keys	Quick Dial
Speed Dial	Group
<p>Example: Speed Dial 10</p>	<p>Example:</p> <p>Method ^{*1} Quick Dial key 08.</p> <p>Method ^{*2} [F4] key and 1 number key.</p>

^{*1} In this example, Group Dial is programmed in Quick Dial 08.

^{*2} In this example, the **[F4]** key is programmed as the Group key, and Group dial number 1 is programmed.

Note

- If you want to erase a digit of the phone number, press the **[Clear]** key.
- The number of pages that you can store in memory depends on the original document images and the scan settings. You can store up to 160 standard pages (ITU-T No.1 chart, Resolution: Standard, halftone mode: off).

Reference

Programming Quick Dial: see P.27 "Quick Dials".

Programming Speed Dial: see P.27 "Speed Dials".

Programming Group Dial: see P.37 "Storing and Editing a Group of Fax Numbers"

Programming Group key: see P.37 "Programming groups in the **[Group]** key"

- 7** Press the **[OK]** key to enter another fax number.

```
Dest.2      OK to Add
9876543210_|||||
```

Note

- Repeat steps **6** and **7** until all destinations are entered.
- If you enter only one destination, press the **[Start]** key.
- The machine stores your message and dials the first number (or, if you selected Send Later, it will return to standby mode and the fax document will be sent at the time that you selected).

- 8** Press the **[Start]** key.

The machine dials the other party's number.

```
0123456789
File No.001   P.001
```

Note

- If the other party's line is busy, your machine will redial.
- If the other party's fax machine answers, both machines connect and your machine sends the document. The other party's Own Name or Own Fax Number appears on the upper line.
- If your line goes through a local switchboard (a PBX) remember to dial the exit code. Press the **[Pause]** key immediately after the code. If the number includes a country code, press the **[Pause]** key after the country code, and then dial the rest of the number. Pauses are displayed as a dash (-) on the display.

The File number. is used for managing documents in memory, and is required when canceling transmission of a document or printing out its contents.

Canceling a Memory Transmission

Before the **[Start]** key is pressed

- 1** Press the **[Stop]** key or **[Clear Modes]** key, or remove the document set in the feeder.

While the document is being scanned in

- 1** Press the **[Stop]** key.
All parts of the document that have been scanned in are cleared. Confirm and press the **[OK]** key.

During transmission

- 1** Confirm the destination.
The destination name or fax number for the current transmission is displayed.

- 2** Press the **[Stop]** key.

```
Cancel Trans.?  ←/OK
[Yes]   No
```

- 3** Confirm and press the **[OK]** key.
Transmission is canceled.

2

Faxing

While the document is awaiting transmission**Limitation**

- Pages already being sent to the destination cannot be canceled, even if you cancel the transmission. The transmission may be sent before you can cancel it, even if you start canceling the transmission before it is fully sent.

2

- 1** Press the **[Job Information]** key, and confirm that "1. Cancel TX/RX" is displayed.

```
Job Information
1.Cancel TX / RX
```

- 2** Press the **[OK]** key.

```
File No. To Cancel
No. [■■■■] (Browse)
```

- 3** Display the file you want to delete.

Enter the file number with the number keys, or search using **[Left]** or **[Right]**.

If you are unable to find the file, it has already been sent.

```
Cancel File? /OK
NO.005
```

- 4** If the document you want to delete is displayed, press the **[OK]** key.

```
Cancel? /OK
[Yes] No
```

- 5** Confirm and press the **[OK]** key.

```
Trans.Cancelled
File Deleted
```

Immediate Transmission

Immediate Transmission is convenient when:

- You wish to send a document immediately as it is scanning.
- You wish to quickly check whether you have successfully connected with the other party's fax machine.
- Your machine's memory is getting full.

The machine dials immediately after you press the **[Start]** key. The message is scanned and transmitted page by page without being stored in memory.

Note

- You can only specify one destination for Immediate Transmission.

- 1** Make sure that the machine is in standby mode.

The display should look like this:

```
Ready 100% 02:39PM
Set Orig./ Enter No.
```

Note

- The Memory indicator should be out. If the Memory indicator is lit, press the **[Memory]** key.

- 2** Place the document facedown in the feeder.

```
Ready 100% 02:39PM
Enter Fax Number
```

Note

- Do not load more than 50 pages into the feeder at one time.
- You can set the document at any point up until you press the **[Start]** key.

To ensure that text, diagrams and images stand out clearly in your document, the machine automatically detects the image density and makes adjustments.

However, if you need to send a document which requires optimum clarity, select the resolution setting appropriate to your needs.

You can select different settings for each page of your document. Simply change the settings for page 2 while page 1 is being scanned.

Limitation

- High resolution images and text are scanned into the machine. If the other party's machine does not support the resolution at which you are sending, this machine automatically switches to a resolution supported by the other party's machine. This machine can send documents in Standard, Detail, and Fine resolution. It can receive documents in Standard and Detail resolution.

Resolution

The **[Resolution]** key gives you control over document quality. The indicators above the button show the current setting. Choose a setting that matches your document.

◆ **Standard:**

Standard quality. Use for most printed or typewritten documents. This is selected when the other resolution indicators are not lit.

◆ **Detail :**

High quality. Use for documents with small print or fine details. Detail resolution is twice the clarity of Standard resolution.

◆ **Fine :**

Very high quality. Use this for high quality reproduction. Fine resolution is four times the clarity of Standard resolution.

◆ **Halftone:**

Use this for optimum quality if your document contains photographs or diagrams with complex shading patterns or gray tones. If you choose this setting, resolution will automatically be Detail.

Note

- You can confirm the resolution for previously sent documents in the Journal.
- Faxing at a higher resolution requires more time. Frequent use of high resolution could cause an increase in your phone bill, especially for long distance transmissions.
- There are two methods for sending documents that contain photographic images - Image priority and Speed priority. If you select Speed priority, you can send your image faster, but the quality of the image may be inferior to when sending with Image priority. See Chapter 7, "User Parameters" (switch 10, bit 7) in the Advanced Features manual.

Dialing

The number keys, Quick Dial, Speed Dial, and Group dial can all be used for dialing.

Entering Numbers Directly

Enter numbers directly using the number keys (1234567890*#) on the right side of the operation panel. Press the **[Pause]** key or **[*]** (Tone) key to enter a pause or tone.

Note

- Maximum length of a fax number: 254 digits.
- Maximum number of documents that can be stored for Memory Transmission: 100
- Maximum number of destinations per Memory Transmission: 140
- The combined total number of destinations that can be stored is 300. However, only 197 destinations can be specified if all of the destinations specified are different.
- The maximum destinations you can specify with the number keys is 67. However, this limitation is subject to memory capacity.

Reference

When sending documents as E-mail, see Chapter 2, "Transmission" in the NIC FAX KIT manual for how to enter E-mail addresses.

1 Make sure that the machine is in standby mode.

2 Carefully place your document into the document table and select any settings you require.

Ready 100% 02:39PM
Enter Fax Number

3 Enter the number with the number keys.

Note

- The number you entered appears in the display.
- If you want to enter another destination, press the **[OK]** key and repeat step **3** above.
- If you make a mistake, press the **[Clear]** key and try again.
- You can enter a pause, tone, or dial options.

Reference

Pause: see P.18 "Entering Pauses".

Tone: see Chapter 3, "Tone Signals" in the Advanced Features manual.

4 Press the **[Start]** key.

0123456789
File No.001 P.001

2

Limitations when dialing with the number keys:

- Destinations entered with the number keys are stored in the machine's internal memory (separate to document storage memory) until they have finished sending. You can store up to 67 destinations for Memory Transmission (including Polling Reception), Transfer Stations and End Receivers when making Transfer Requests, and Groups. (Quick Dials and Speed Dials are not included.)
Example: If 60 destinations have already been registered with the number keys for Groups, you can register another 7 destinations for Memory Transmission with the number keys.
- The remaining memory for storing documents appears in the display. Because destinations are stored in a different memory, the remaining memory in the display does not change when you store new destinations.

Entering Pauses

When dialing an outside line through a PBX, you must enter a number, such as "0", at the beginning of the number, and it may take a moment after you have dialed the number before a connection is made to an outside line. If this occurs, enter a pause after the "0". If you enter a pause, a 2-second pause is inserted before the outside number is dialed.

Note

- A pause is shown as a "-" character on the display.
- You can enter a pause in numbers stored in Quick Dials and Speed Dials.

Limitation

- You cannot enter a pause at the beginning of a fax number

Switching to Tone Signals

This feature allows a machine connected to a pulse dialing line to send tone signals (for example if you want to use a special service on a tone dialing line). For details on basic services, please contact your service representative. This feature is not necessary with a Tone dialing line. See Chapter 3, "Tone Signals" in the Advanced Features manual.

Using Quick Dial

You can specify destinations simply by pressing the Quick Dial.

You must program the destination's fax number in a Quick Dial beforehand.

Additionally, you can store a name for the destination in Quick Dials.

Note

- To store, edit, or delete a Quick Dial, see P.27 "Storing and Editing Fax Numbers".
- To check the contents of all Quick Dials, print the Quick Dial list. See Chapter 6, "Lists You Can Print Out Yourself" in the Advanced Features manual.

Reference

When sending documents as E-mail, see Chapter 2, "Transmission" in the NIC FAX KIT manual for how to enter E-mail addresses.

- 1 Make sure that the machine is in standby mode.**

- 2** Carefully place your fax document into the auto document feeder and select any settings you require.

```
Ready 100% 02:39PM
Enter Fax Number
```

- 3** Press the Quick Dial that is programmed with the destination.

```
Dest.1 OK to Add
001 ABC COMPANY
```

Note

- When a name is stored for the destination, the name is displayed, and when no name is stored, the fax number is displayed.
- If you want to enter another destination, press the **[OK]** key and repeat step **3** above or enter a number manually.
- When dialing another destination using a Quick Dial, you do not need to press the **[OK]** key.
- If you make a mistake, press the **[Stop]** key, and the display will return to that in step **2**.

- 4** Press the **[Start]** key.

```
ABC COMPANY
File No.001 P.001
```

Using Speed Dial

You can specify destinations simply by pressing the **[Speed Dial]** key and a Speed Dial code (00 to 99).

You must store the destination's fax number in a Speed Dial beforehand. Additionally, you can store a name for the destination in Speed Dials.

Note

- To store, edit, or delete Speed Dial entries, see P.27 "Storing and Editing Fax Numbers".
- To check the contents of all Speed Dials, print the Speed Dial list. See Chapter 6, "Lists You Can Print Out Yourself" in the Advanced Features manual.

Reference

When sending documents as E-mail, see Chapter 2, "Transmission" in the NIC FAX KIT manual for how to enter E-mail addresses.

- 1** Make sure that the machine is in standby mode.
- 2** Carefully place your fax document into the auto document feeder and select any settings you require.

```
Ready 100% 02:39PM
Enter Fax Number
```

- 3** Press the **[Speed Dial]** key.

```
Speed Dial:Enter No.
[0-9]
```

2

Faxing

- 4** Using the number keys, enter the Speed Dial number (00 to 99) that is programmed with the destination.

```
Dest.1   OK to Add
000 DEF COMPANY
```

2

Note

- When a name is stored for the destination, the name is displayed, and when no name is stored, the fax number is displayed.
- If you want to enter another destination, press the **[OK]** key and repeat steps **3** and **4** above.
- If you make a mistake, press the **[Stop]** key, and the display will return to that in step **4**.

- 5** Press the **[Start]** key.

```
DEF COMPANY
File No.001   P.001
```

Using Groups

You can store multiple destinations as a single Group and simply specify a particular Group.

You must store the destinations' fax number in a Group beforehand.

Additionally, you can store destination names and a Group name in Groups.

Limitation

- Quick Dials programmed with Groups cannot be used for any other function.
- You cannot use Immediate Transmission to send Groups. You can only use Memory Transmission.

Note

- To store, edit, or delete Groups, see P.37 "Storing and Editing a Group of Fax Numbers".
- To check the contents of all Groups, print the Group Dial list. See Chapter 6, "Lists You Can Print Out Yourself" in the Advanced Features manual. The method for specifying Groups differs according to the way they were programmed.
 - When programmed in a Quick Dial: Press the Quick Dial.
 - When not programmed in a Quick Dial: First, Program the Group function in a User Function key. When you want to specify a destination, press the Group key, and then press the Group number. (See Chapter 6, "User Function Keys" in the Advanced Features manual.)
- You can program the Group function in User Function keys **[F1]** to **[F4]**. (See Chapter 6, "User Function Keys" in the Advanced Features manual.)

When specifying a Group with a Quick Dial

Make sure that the Memory indicator is lit, and if it is not lit, press the **[Memory]** key to light it.

- 1** Make sure that the machine is in standby mode.
- 2** Carefully place your fax document into the auto document feeder and select any settings you require.

```
Ready   100% 02:39PM
Enter Fax Number
```

- 3** Press the Quick Dial that is programmed with the destination.

```
Dest.1      OK to Add
001:GP.D1  GROUP 1
```

Note

- If you want to specify another Group, press the **[OK]** key, and then repeat step **3** above.
- If you make a mistake, press the **[Clear]** key, and the display will return to that in step **2**.

- 4** Press the **[Start]** key.

```
Storing...Memory 99%
File No.001      P.001
```

When specifying a Group with the Group key

Confirm that the Memory indicator is not lit, and if it is not lit, press the **[Memory]** key to light it.

Note

- Before using the **[Group]** key, you must program the Group function in a User Function key. (See Chapter 6, "User Function Keys" in the Advanced Features manual.)

- 1** Make sure that the machine is in standby mode.

- 2** Carefully place your fax document into the auto document feeder and select any settings you require.

```
Ready      100% 02:39PM
Enter Fax Number
```

- 3** Press the User Function key programmed with the Group function.

```
GROUP Dial:Enter No.
[GP.D_]
```

- 4** Enter the Group number (1 to 7) with the number keys.

```
Dest.1      OK to Add
G1 GROUP 1
```

Note

- If you want to specify another Group, press the **[OK]** key, and then repeat step **3** above.
- If you make a mistake, press the **[Clear]** key, and the display will return to that in step **2**.

- 5** Press the **[Start]** key.

```
Storing...Memory 99%
File No.001      P.001
```

2

Reception Modes

The machine can treat incoming fax documents and telephone calls in two ways.

2

◆ Manual Receive

Use this mode if your line is shared by a fax machine and a telephone but you wish to answer all calls yourself and decide whether they are fax documents or telephone calls. You must manually hit the **[Start]** key to receive a fax.

The machine will ring continuously until you answer the call, so you have to be near the machine at all times. The Manual Receive indicator is lit when the machine is in this mode.

◆ Auto Receive

Use this mode if you have a dedicated fax line. The machine assumes all calls are fax documents. It will ring once to alert you of an incoming call, and then starts receiving.

🔍 Reference

To receive Internet Fax documents, see Chapter 2, "Reception" in the NIC FAX KIT manual.

How to Select the Reception Mode

The Manual Receive indicator is lit when the machine is in Manual Receive mode. To switch to a different mode, follow the steps below.

- 1 Press the **[Reception Mode]** key.

```
Reception Mode ◀▶/OK
[Auto Sense]
```

- 2 Press **⏪** or **⏩** to select the reception mode.

```
Reception Mode ◀▶/OK
Manual Receive
```

- 3 Press the **[OK]** key.

```
Ready 100% 02:39PM
Set Orig./ Enter NO.
```

3. Setup

Initial Settings and Adjustments

If you have not already the initial procedure (or if you need to change the initial settings), you must enter a few settings and make a few adjustments before connecting your machine to the telephone line.

◆ Own Name

This should be your name or company name, in 20 characters or less. During communication, if the other party's fax machine supports Own Name, this replaces the Own Fax Number that follows. This name will appear on the display of the other party's Fax machine, and the name registered on that machine will appear on yours.

● Limitation

- The registered name will not be used unless the other party has a same machine of the same make that supports the Own Name feature.

◆ Fax Header

This is ordinarily the telephone number of the line your machine is connected to. Your fax header can be up to 32 characters long, and is printed on the header of every page you send. In the United States, a fax header containing the telephone number is required by law.

◆ Own Fax Number (Required by international law)

This is your fax machine's phone number, which must include country and area codes, in 20 characters or less. During any communication, your Own Fax Number appears on their display. (Conversely their Own Fax Number appears on your display.)

● Important

- When sending a fax, your Own Fax Number is required by international law. You cannot legally connect a fax machine to the telephone system if the Own Fax Number is not programmed. Further, the Fax Header and the date and time of transmission must be included in the header of all pages faxed to, from, or within the United States.

● Note

- You can confirm the Own Name, Fax Header, and Own Fax Number settings in the User Parameters List.
- In order to send and receive documents using the Internet Fax feature, you must have your network administrator make E-mail server settings and configure the fax machine for connection to your LAN. See Chapter 1, "Getting Ready" in the NIC FAX KIT manual.

Setup

Initial Settings

During the course of this procedure you will have to enter letters and other characters.

Use the number keys to enter numbers. Use Quick Dial keys for entering letters, the **[OK]** key to accept a character, the **[Space]** or **[Symbol]** key (depending on your fax machine's configuration) to enter spaces, and the **[Symbol]** key to enter symbols (P.46 "Entering Characters").

3

Note

- Make sure the machine is in stand-by mode before making the following settings.

Storing and Editing Programmed Data

The following procedure describes how to make initial settings.

- 1** Press the **[User Tools]** key.

```
User Tools Main Menu
1.Program / Delete
```

- 2** Press **[Left]** or **[Right]** to display "3. Setup".

```
User Tools Main Menu
3.Setup
```

- 3** Press the **[OK]** key.

```
Setup:
1.Monitor Volume
```

- 4** Press **[Left]** or **[Right]** to display "4. Fax Information".

```
Setup:
4.Fax Information
```

- 5** Press the **[OK]** key.

Confirm that "1. Own Name" is displayed.

```
Fax Information:
1.Own Name
```

- 6** Press the **[OK]** key.

```
Own Name[ABC]
_
```

- 7** Enter your Own Name.

```
Own Name[ABC] OK
MAIN OFFICE_
```

Note

- If you want to erase a character of the name, press the **[Clear]** key.

Reference

P.46 "Entering Characters"

- 8** Press the **[OK]** key.

Your Own Name is programmed.

```
Fax Information:
1.Own Name
```

- 9** Press **[Left]** or **[Right]** to display "2. Fax Header".

```
Fax Information:
2.Fax Header
```

- 10** Press the **[OK]** key.

The programmed Own Name is displayed.

```
Header[ABC] OK
MAIN OFFICE
```

3

11 Enter your Fax Header.

If your Fax Header is the same as your Own Name, go to step 12.



12 Press the [OK] key.

Your Fax Header is programmed.

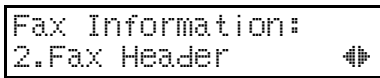

13 Press [Left] or [Right] to display "3. Own Fax Number".

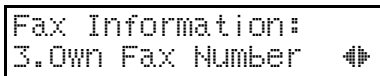

14 Press the [OK] key.



15 Enter your Own Fax Number.



Note

The format of the number is normally as follows: International Dial Prefix, Your Country Code, Your Area Code (do not insert a pause after your Area Code), followed by your telephone number. Check the International Dialing Prefix and the Country Code with your local telecommunications operator.

Characters you can enter include numerals 0-9, plus signs (+), and spaces.

16 Press the [OK] key.

Your Own Fax Number is programmed.

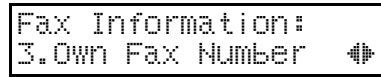

17 Press the [User Tools] key to return to standby display.

Deleting Programmed Data

The following procedure describes how to delete programmed data.

1 Press the [User Tools] key.



2 Press [Left] or [Right] to display "3. Setup".



3 Press the [OK] key.



4 Press [Left] or [Right] to display "4. Fax Information".

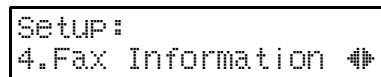

5 Press the [OK] key.

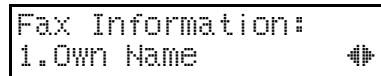

Setup

- 6** Press \leftarrow or \rightarrow to display the item you want to delete.

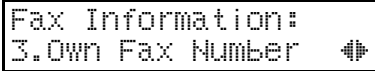

```
Fax Information:
3.Own Fax Number  ←→
```

- 7** Press the [OK] key.



```
Fax Number      OK
0123456789 ██████████
```

3

- 8** Press the [Clear] key.



```
Fax Number
_ ██████████
```

- 9** Press the [OK] key.

The programmed information is deleted.

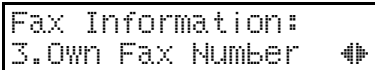

```
Fax Information:
3.Own Fax Number  ←→
```

- 10** Press the [User Tools] key to return to standby mode.

Storing and Editing Fax Numbers

You can store numbers that you often use in the machine's memory. A stored number will remain in memory even if the power is cut.

You can store numbers in two ways.

◆ Quick Dials

Each fax number is assigned to its own key. To dial that number, just press the key. You can store up to 30 numbers in this way.

◆ Speed Dials

The number is given a two-digit code. To dial the number, press the **[Speed Dial]** key and enter the code. There are 100 Speed Dial codes available, numbered 00 to 99.

🔍 Reference

You can also program E-mail addresses as Quick Dials, Speed Dials, and Group Dials. See Chapter 4, "Registering E-mail Addresses" and Chapter 5, "Address Book (Quick Dial, Speed Dial, Group Dial)" in the NIC FAX KIT manual.

Storing Quick Dial Numbers

The following procedure describes how to store fax numbers in Quick Dial keys.

⚠ Limitation

- You cannot store fax numbers in Quick Dials used for groups and programs.

📝 Note

- The combined total number of fax numbers that can be stored is 30.
- Maximum number of digits per fax number: 254
- Maximum number of characters per name: 20
- You can confirm fax numbers stored in Quick Dials on the Quick Dial List (See Chapter 6, "Printing Dial Lists" in the Advanced Features manual).
- You can print a Quick Dial label showing the contents of each Quick Dial (See Chapter 6, "Printing a Quick Dial Label" in the Advanced Features manual).
- You can use the Quick Dial keys to store individual fax numbers, or to register functions such as groups, programs, and auto documents.

1 Press the **[User Tools]** key.

```
User Tools Main Menu
1.Program / Delete
```

Confirm that "1. Program / Delete" is displayed.

Setup

2 Press the **[OK]** key.

```

Program / Delete:
1.Prog. Quick Dial

```

Confirm that "1. Prog. Quick Dial" is displayed.

3 Press the **[OK]** key.

```

Press Key to Program
(Browse)

```

4 Display the number of the Quick Dial key you want to store.

Press a Quick Dial key, or search using **[Left]** or **[Right]**.

```

001 Fax No.
_

```

Note

- If a Quick Dial has already been stored, the contents are displayed. Press **[Left]** or **[Right]** to select a Quick Dial that is not programmed, then press the **[OK]** key.

5 Enter the fax number with the number keys.

```

001 Press OK
9876543210_

```

Note

- If you want to erase a digit of the number, press the **[Clear]** key.
- If you press the **[Pause/Redial]** key, the last 10 fax numbers dialed are displayed. Press **[Left]** or **[Right]** to select the fax number you want to specify, and then press the **[OK]** key.

- Make sure a Dial Option is stored in one of the User Function keys, and then enter the other party's fax number and press the User Function key that contains the Dial Option. You can specify SUB or SEP, SID, PWD, and sub-addresses (See Chapter 3, "Dial Options" in the Advanced Features manual).

6 Press the **[OK]** key.

The fax number is programmed.

```

001[ABC] Name
_

```

7 Enter the name.

```

001[ABC] OK
ABC COMPANY_

```

Note

- Under rare circumstances, garbled characters may appear during name registration if you use the **[Pause/Redial]** key to display the fax number of parties located in other countries. If this happens, simply delete the garbled characters using the **[Left]** and **[Clear]** keys, then go on to enter the name.

8 Press the **[OK]** key.

The name is programmed.

Note

- When the optional G4 unit is installed, "G3/G4: Select" is displayed. Press **[Left]** or **[Right]** to select G3 or G4, and then press the **[OK]** key.

```

Label Insert: /OK
Yes [No]

```

- 9** Press **[Left]** or **[Right]** to select either "Yes" or "No".

Note

- Label insertion allows the receiver's name that is programmed in Quick Dial or Speed Dial to be printed on the fax when it is received at the other end. See Chapter 3, "Label Insertion" in the Advanced Features manual.

```
Label Insert:  ←/OK
[Yes]  No
```

- 10** Press the **[OK]** key.

```
Program / Delete:
1.Prog. Quick Dial ←
```

If you want to store another Quick Dial, go to step **8**.

- 11** Press the **[User Tools]** key to return to the standby mode.

Editing Quick Dial Numbers

The following procedure describes how to edit fax numbers stored in Quick Dial keys.

- 1** Press the **[User Tools]** key.

```
User Tools Main Menu
1.Program / Delete ←
```

Confirm that "1. Program / Delete" is displayed.

- 2** Press the **[OK]** key.

```
Program / Delete:
1.Prog. Quick Dial ←
```

Confirm that "1. Prog. Quick Dial" is displayed.

- 3** Press the **[OK]** key.

```
Press Key to Program
(Browse ←/→)
```

- 4** Display the Quick Dial key you want to edit.

Press a Quick Dial key or search using **[Left]** or **[Right]**.

```
Program?  ←/OK
001 ABC COMPANY
```

- 5** Press the **[OK]** key.

```
001          Press OK
9876543210 ██████████
```

- 6** Press the **[Clear]** key and enter the new number.

```
001          Press OK
5432109876_ ██████████
```

Note

- The previously entered fax number flashes. Pressing the **[Clear]** key deletes all digits of the number. If you want to delete a single digit, press **[Left]** or **[Right]** to move the cursor to the digit to be deleted, then press the **[Clear]** key.
- If you do not want to change the number, go to step **7**.
- After programming a user function key with a Dial Option and registering a fax number, you can press that key and program the SUB, SEP, SID, PWD, or sub-address.

- 7** Press the **[OK]** key.

The fax number is changed.

```
001[ABC]      /OK
ABC COMPANY ██████████
```

3

Setup

8 Enter the name.

```

@01[ABC]      OK
DEF COMPANY_■■■■■■■■■■
  
```

Note

- If you do not want to change the name, go to step **9**.
- The previously entered name flashes. Pressing the **[Clear]** key deletes all characters of the name. If you want to delete a single character, press **⏪** or **⏩** to move the cursor to the character to be deleted, then press the **[Clear]** key.

9 Press the **[OK]** key.

The name is changed.

```

Label Insert:  ⏪/OK
[Yes]   No
  
```

Note

- When the optional G4 unit is installed, "G3/G4: Select" is displayed. Press **⏪** or **⏩** to select G3 or G4, then press the **[OK]** key.

10 Press **⏪** or **⏩** to select "Yes" or "No".**Note**

- Label insertion allows the receiver's name that is programmed in Quick Dial or Speed Dial to be printed on the fax when it is received at the other end. See Chapter 3, "Label Insertion" in the Advanced Features manual.

```

Label Insert:  ⏪/OK
Yes   [No]
  
```

11 Press the **[OK]** key.

```

Program / Delete:
1.Prog. Quick Dial ⏪
  
```

If you want to edit another Quick Dial, go to step **8**.

12 Press the **[User Tools]** key to return to standby mode.**Deleting Quick Dial Numbers**

The following procedure describes how to delete fax numbers stored in Quick Dial keys.

1 Press the **[User Tools]** key.

```

User Tools Main Menu
1.Program / Delete ⏪
  
```

Confirm that "1. Program / Delete" is displayed.

2 Press the **[OK]** key.**3** Press **⏪** or **⏩** to display "2. Del. Quick Dial".

```

Program / Delete:
2.Del. Quick Dial ⏪
  
```

4 Press the **[OK]** key.

```

Press Key to Delete
(Browse ⏪)
  
```

5 Display the Quick Dial key that you want to delete.

Press a Quick Dial key or search by pressing \leftarrow or \rightarrow .

```

Delete?           ←/OK
001 ABC COMPANY
  
```

The number of the Quick Dial key and the fax number or name are displayed.

6 Press the **[OK]** key.

The stored data (fax number and name) is deleted.

```

Program / Delete:
2.Del. Quick Dial ←
  
```

If you want to delete another Quick Dial key, go to step **4**.

7 Press the **[User Tools]** key to return to standby mode.

Printing a Quick Dial Key Label

To print a template that can be used to make labels for Quick Dial keys, perform the following procedure.

1 Press the **[User Tools]** key.

2 Press \leftarrow or \rightarrow to display "2. Reports / Lists".

```

User Tools Main Menu
2.Reports / Lists ←
  
```

3 Press the **[OK]** key.

4 Press \leftarrow or \rightarrow to display "4. Quick Dial Label".

```

Reports / Lists
4.Quick Dial Label ←
  
```

5 Press the **[OK]** key.

6 Press the **[Start]** key.

The Quick Dial label is printed.

Once the label is printed, the machine returns to the standby mode.

Setup

Quick Dial Key Labels

The Quick Dial key label will have the destination, Group, Program, or Auto Document name programmed in Quick Dials.

 **Note**

- A protective transparent film is attached to the operation panel. Peel off the film and place the Quick Dial key labels onto the operation panel.

3

P. 1

* * * QUICK KEY LABEL (FEB. 1. 2001 9:13AM) * * *

Time printed FAX HEADER: ABC COMPANY

01: abc com pany	02: BCD. com pany	03: cde com pany	04:	05:	06:	07:	08:	09:	10: Group 1
11:	12:	13:	14:	15: MAP	16:	17:	18:	19:	20:
21:	22:	23:	24:	25:	26:	27:	28:	29:	30:

Printout of Quick Dial numbers assigned to keys,
including programmed names (up to 20 characters)

01:	02:	03:	04:	05:	06:	07:	08:	09:	10:
11:	12:	13:	14:	15:	16:	17:	18:	19:	20:
21:	22:	23:	24:	25:	26:	27:	28:	29:	30:

Labels without printed names. (Write in names yourself.)

abc comp any	BCD. comp any	cde comp any							Group 1
				MAP					

PLEASE CUT THE SHEET INTO THREE LABELS ALONG THE DOTTED LINE,
AND PUT LABELS ON THE QUICK DIAL PANEL.

Printout of Quick Dial numbers assigned to keys, including programmed names (up to 16 characters)

GFWTLBGN

Storing Speed Dial Numbers

If you store numbers in Speed Dials, you can specify the fax number simply by pressing the **[Speed Dial]** key, and entering a two-digit Speed Dial number.

The following procedure describes how to store fax numbers in Speed Dials.

Note

- The combined total number of Speed Dial numbers that can be stored is 100.
- You can specify numbers from 00 to 99.
- The maximum number of digits per fax number is 254.
- The maximum number of characters per name is 20.
- You can confirm the contents of Speed Dial numbers in the Speed Dial list. (See Chapter 6, "Printing Dial Lists" in the Advanced Features manual.)

1 Press the **[User Tools]** key.

```
User Tools Main Menu
1.Program / Delete
```

Confirm that "1. Program / Delete" is displayed.

2 Press the **[OK]** key.

3 Press **[Left]** or **[Right]** to display "3. Prog. Speed Dial".

```
Program / Delete:
3.Prog. Speed Dial
```

4 Press the **[OK]** key.

```
Enter No. to Program
[00] (Browse)
```

5 Display the number of the Speed Dial you want to store (00 to 99).

Enter the Speed Dial number with the number keys, or search using **[Left]** or **[Right]**.

```
001 Fax No.
_
```

Note

- If you want to delete a digit of the number, press the **[Clear]** key and enter the correct number.
- If a Speed Dial number has already been stored, the contents are displayed. Press **[Left]** or **[Right]** to select an unprogrammed number, then press the **[OK]** key.

6 Enter the fax number with the number keys.

```
000 Press OK
5432109876_
```

Note

- If you want to delete a digit of the number, press the **[Clear]** key.

7 Press the **[OK]** key.

The fax number is programmed.

```
000[ABC] Name
_
```

8 Enter the name.

```
000[ABC] OK
DEF COMPANY_
```

Setup

9 Press the **[OK]** key.

The name is programmed.

```
Label Insert:  ←/OK
                Yes  [No]
```

Note

- When the optional G4 unit is installed, "G3/G4: Select" is displayed. Press **⏪** or **⏩** to select G3 or G4, and then press the **[OK]** key.

3**10** Press **⏪** or **⏩** to select "Yes" or "No".**Note**

- Label insertion allows the receiver's name that is programmed in Quick Dial or Speed Dial to be printed on the fax when it is received at the other end. See Chapter 3, "Label Insertion" in the Advanced Features manual.

```
Label Insert:  ←/OK
                [Yes] No
```

11 Press the **[OK]** key.

```
Program / Delete:
3.Prog. Speed Dial ←
```

If you want to store another Speed Dial number, go to step **4**.

12 Press the **[User Tools]** key to return to standby mode.**Editing Speed Dial Numbers**

The following procedure describes how to edit programmed Speed Dial numbers.

1 Press the **[User Tools]** key.

```
User Tools Main Menu
1.Program / Delete ←
```

Confirm that "1. Program / Delete" is displayed.

2 Press the **[OK]** key.**3** Press **⏪** or **⏩** to display "3. Prog. Speed Dial".

```
Program / Delete:
3.Prog. Speed Dial ←
```

4 Press the **[OK]** key.

```
Enter No. to Program
[0-9] (Browse ←)
```

5 Display the Speed Dial number you want to edit (00 to 99).

Enter the Speed Dial number with the number keys or search using **⏪** or **⏩**.

```
Program? ←/OK
000 DEF COMPANY
```

Note

- If you want to delete a digit of the number, press the **[Clear]** key and enter the correct number.
- The Speed Dial number and the fax number or name are displayed.

Setup

Deleting Speed Dial Numbers

The following procedure describes how to delete fax numbers in Speed Dials.

- 1** Press the **[User Tools]** key.

```
User Tools Main Menu
1.Program / Delete
```

Confirm that "1. Program / Delete" is displayed.

- 2** Press the **[OK]** key.

- 3** Press **[Left]** or **[Right]** to display "4. Del. Speed Dial".

```
Program / Delete:
4.Del. Speed Dial
```

- 4** Press the **[OK]** key.

```
Enter No. to Delete
[0-9] (Browse)
```

- 5** Display the Speed Dial number you want to delete (00 to 99).

Enter the Speed Dial number with the number keys or search using **[Left]** or **[Right]**.

```
Delete? /OK
000 DEF COMPANY
```

The Speed Dial number and the fax number or name are displayed.

Note

- If you want to delete a digit of the number, press the **[Clear]** key and enter the correct number.

- 6** Press the **[OK]** key.

The programmed data (fax number and name) is deleted.

```
Program / Delete:
4.Del. Speed Dial
```

If you want to delete another name, go to step **4**.

- 7** Press the **[User Tools]** key to return to standby mode.

Storing and Editing a Group of Fax Numbers

If you regularly broadcast documents to the same set of destinations, you can combine these numbers into a group. Then just select the group and each number will be dialed in sequence automatically.

There are two ways of programming Groups:

◆ Programming groups in Quick Dial keys

If you program a group in a Quick Dial key, you can specify that group by pressing a Quick Dial key. However, if you use Quick Dial keys to program groups, you will be able to program fewer Quick Dial keys.

! Limitation

- You cannot store another function (Quick Dials, Auto Documents, or Programs) in a Quick Dial key already used for a group. Also, you cannot store groups in a Quick Dial key already used for another function.

◆ Programming groups in the **[Group]** key

To program a group in the **[Group]** key, you must first assign the Group feature to a Function key. To send a fax, press the **[Group]** key, and then enter the group number (1 to 7).

Storing a Group of Fax Numbers

You can register the following items in a Group:

- Destination fax numbers
- Group name (up to 20 characters)

You can enter destination numbers by Quick Dial keys, Speed Dials, or the number keys.

Note

- You can register up to 7 Groups with 140 numbers each.
- The combined maximum number of destinations you can register in all Groups is 197. This 197 can be composed of up to 30 Quick Dial numbers, 100 Speed Dial numbers and 67 numbers entered directly with the number keys.
- The number of destinations that can be registered with the number keys depends on how the machine is used. In theory you can register up to a combined maximum of 67 destinations with the number keys for all groups.
- If you register a Group with the number keys when a file is waiting to be transmitted, a message is shown. You sometimes cannot register any more destinations even when the number of specified destination is 66 or less.
- If you register the same destination more than once with a Speed Dial or Quick Dial in Groups, it is only counted as one item. However, if you register two or more identical destinations with the ten keys they will be counted as two or more items.

Setup

- If all destinations are different, you may not be able to store 140 destinations in a Group.
- It is recommended that you print the Group Dial list and keep it when you register or change destinations. See Chapter 6, "Printing Dial Lists" in the Advanced Features manual.
- How to count numbers.

3

	Registered items	Total Numbers
Group 1	Quick Dial: [01], [03], [05] Speed Dial: [01], [02], [10] Ten Key: 0312345678	10 numbers
Group 2	Quick Dial: [01], [05] Speed Dial: [01], [02], [08] Ten Key: 0312345678, 0451119999	
	Registered items	Total Numbers
Group1	Quick Dial: [01], [02], [03] Speed Dial: [01], [02], [03] Ten Key: 0312345678	14 numbers
Group2	Quick Dial: [04], [05] Speed Dial: [04], [05], [06] Ten Key: 0312345678, 0451119999	

- This section describes how to program a Group.

- 1** Press the **[User Tools]** key.

```
User Tools Main Menu
1.Program / Delete
```

Confirm that "1. Program / Delete" is displayed.

- 2** Press the **[OK]** key.

- 3** Press **[Left]** or **[Right]** to display "5. Prog. Group Dial".

```
Program / Delete:
5.Prog. Group Dial
```

- 4** Press the **[OK]** key.

```
Enter No./ Press Key
[GP.D_] (Browse)
```

- 5** Display the number of the group you want to store (1 to 7).

Enter the group number with the number keys, or search using **[Left]** or **[Right]**.

```
GP.D1:#1 Fax NO.
_
```

Note

- If a group has already been stored, the contents are displayed. Press **[Left]** or **[Right]** to select a group number that is not programmed, then press the **[OK]** key.
- If a group is programmed, but no name is specified, the group number only is displayed on the lower line of the display.

6 Specify the destination using one of the following three methods:

Enter the fax number with the number keys.

```
GP.D1:#1   Press OK
0123456789_|||||
```

Press a Quick Dial key.

```
GP.D1:#1   Press OK
001 ABC COMPANY
```

Press the **[Speed Dial]** key and enter a Speed Dial number.

```
GP.D1:#1   Press OK
000 DEF COMPANY
```

Note

- If you specify a Quick Dial or Speed Dial that is not programmed, "This key is Not Programmed" is displayed. Re-specify the destination.

7 Press the **[OK]** key.

The destination is programmed.

8 Press the **[◀]** or **[▶]** to select "Add" or "Exit".

```
Program?   ◀/▶/OK
[Add] Delete Exit
```

Note

- When the optional G4 unit is installed, "G3/G4: Select" is displayed. Press **[◀]** or **[▶]** to select G3 or G4, and then press the **[OK]** key.

9 Press the **[OK]** key.

If you selected "Exit", go to step **10**.

10 Repeat steps **6** to **9** and program a destination.**11** Enter the group name.

If you do not want to program a group name, press the **[OK]** key and go to step **12**.

```
GP.D1[ABC]   Name
GROUP A_|||||
```

Note

- If you want to delete a character of the name, press the **[Clear]** key.

12 Press the **[OK]** key.

The group name is programmed.

```
Assign to key? ◀/▶/OK
Yes [NO]
```

13 Press **[◀]** or **[▶]** to select "Yes" or "No" to be programmed in the Quick Dial.

```
Assign to key? ◀/▶/OK
[Yes] NO
```

14 Press the **[OK]** key.

If you selected "No", go to step **15**.

```
Press Quick Dial Key
[0_|||]
```

15 Press the Quick Dial key you want to program.

```
Press Quick Dial Key
[002]
```

Setup

16 Press the **[OK]** key.

```
Program / Delete:
5.Prog. GROUP Dial
```

17 Press the **[User Tools]** key to return to standby mode.

Editing a Group

You can add destinations or edit the group name for programmed groups. To edit a destination:

- For destinations programmed in Quick Dials or Speed Dial, edit the contents of the programmed Quick Dial or Speed Dial.
- For destinations programmed with the number keys, delete the destination you want to edit from the group, and then program the new destination.

Editing a Group Name

The following procedure describes how to edit a group name.

1 Press the **[User Tools]** key.

```
User Tools Main Menu
1.Program / Delete
```

Confirm that "1. Program/Delete" is displayed.

2 Press the **[OK]** key.

3 Press **[◀]** or **[▶]** to display "5. Prog. Group Dial".

```
Program / Delete:
5.Prog. GROUP Dial
```

4 Press the **[OK]** key.

```
Enter No./ Press Key
[GP.D_] (Browse)
```

5 Display the number of the group you want to edit (1 to 7).

Enter the group number with the number keys, or search using **[◀]** or **[▶]**.

```
Program?
GP.D1 GROUP A
```

6 Press the **[OK]** key.

```
Change Dest.?:
[Yes] NO
```

7 Press **[◀]** or **[▶]** to select "No".

```
Change Dest.?:
Yes [NO]
```

8 Press the **[OK]** key.

```
GP.D1[ABC]
GROUP A
```

9 Press the **[Clear]** key and enter the new name.

```
GP.D1[ABC]
GROUP B
```

Note

- If you want to delete a character of the name, press the **[Clear]** key.
- If you press the **[Cancel]** key, the display will return to that shown for step **8**.
- If you are finished, press the **[User Tools]** key.

- 10** Press the **[OK]** key.

The name is changed.

```
Assign to Key?  ←/OK
Yes  [NO]
```

- 11** Press **⏪** or **⏩** to select "Yes" if the group was programmed in a Quick Dial, or select "No" if it was not.

```
Assign to Key?  ←/OK
[Yes]  No
```

- 12** Press the **[OK]** key.

If you selected "No", go to step **10**.

```
Press Quick Dial Key
[002]
```

Note

- If you want to edit a programmed Quick Dial key, press the Quick Dial key and then the **[OK]** key.

- 13** Press the **[OK]** key.

```
Program / Delete:
5.Prog. GROUP Dial ←
```

If you want to program another group name, go to step **4**.

- 14** Press the **[User Tools]** key to return to standby mode.

Adding a Fax Number to a Group

The following procedure describes how to add a destination to a group.

- 1** Press the **[User Tools]** key.

```
User Tools Main Menu
1.Program / Delete ←
```

Confirm that "1. Program / Delete" is displayed.

- 2** Press the **[OK]** key.

- 3** Press **⏪** or **⏩** to display "5. Prog. Group Dial".

```
Program / Delete:
5.Prog. GROUP Dial ←
```

- 4** Press the **[OK]** key.

```
Enter No./ Press Key
[GP.D_] (Browse ←)
```

- 5** Display the number of the group to which you want to add a number (1 to 7).

Enter the group number with the number keys, or search using **⏪** or **⏩**.

```
Program?  ←/OK
GP.D1 GROUP A
```

- 6** Press the **[OK]** key.

```
Change Dest.?: ←/OK
[Yes]  No
```

3

Setup

- 7** Press **◀** or **▶** to select "Yes" and press the **[OK]** key.

```

Program?      ←/OK
[Add] Delete  Exit
  
```

Note

- If you have finished adding destinations, select "Exit" and go to step **10**.

3

- 8** Press **◀** or **▶** to select "Add" and press the **[OK]** key.

```

GP.D1:#5      Fax No.
_#####
  
```

- 9** Specify the destination using one of the following three methods:

Enter the fax number with the number keys.

```

GP.D1:#5      Press OK
0123456789_#####
  
```

Press a Quick Dial key.

```

GP.D1:#5      Press OK
001 ABC COMPANY
  
```

Press the **[User Tools]** key and enter a Speed Dial number.

```

GP.D1:#5      Press OK
000 DEF COMPANY
  
```

Note

- If you specify a Quick Dial or Speed Dial that is not programmed, "This key is Not Programmed" is displayed. Re-specify the destination.

- 10** Press the **[OK]** key.

The destination is added.

Note

- When the optional G4 unit is installed, "G3/G4: Select" is displayed. Press **◀** or **▶** to select G3 or G4, and then press the **[OK]** key.

- 11** To add another destination, repeat steps **7** to **10**.

- 12** If you have finished adding destinations, select "Exit".

```

Program?      ←/OK
Add Delete [Exit]
  
```

- 13** Press the **[OK]** key.

```

GP.D1[ABC]    /OK
GROUP A#####
  
```

Note

- If you want to change the group name, press the **[Clear]** key and enter the new name.

- 14** Press the **[OK]** key.

```

Assign to Key? ←/OK
Yes [No]
  
```

- 15** Press **◀** or **▶** to select "Yes" if the group was programmed in a Quick Dial, or select "No" if it was not.

```

Assign to Key? ←/OK
[Yes] NO
  
```

16 Press the **[OK]** key.

If you selected "No", go to step **17**.

```
Press Quick Dial Key
[002]
```

Note

- If you want to edit a programmed Quick Dial, press the Quick Dial, and then the **[OK]** key.

17 Press the **[OK]** key.

```
Program / Delete:
5.Prog. GROUP Dial
```

If you want to add another destination to the group, go to step **4**.

18 Press the **[User Tools]** key to return to standby mode.

Deleting a Group

The following procedure describes how to delete a destination from a group.

- When you delete a destination from a group programmed in a Quick Dial or a Speed Dial, the contents of the Quick Dial or Speed Dial are not deleted.

To delete a destination from a group

1 Press the **[User Tools]** key.

```
User Tools Main Menu
1.Program / Delete
```

Confirm that "1. Program / Delete" is displayed.

2 Press the **[OK]** key.**3** Press **⏪** or **⏩** to display "5. Prog. Group Dial".

```
Program / Delete:
5.Prog. GROUP Dial
```

4 Press the **[OK]** key.

```
Enter No. / Press Key
[GP.D_] (Browse)
```

5 Display the group number for the destination you want to delete (1 to 7).

Enter the group number with the number keys, or search using **⏪** or **⏩**.

```
Program? /OK
GP.D1 GROUP A
```

6 Press the **[OK]** key.

```
Change Dest.?: /OK
[Yes] NO
```

7 Press **⏪** or **⏩** to select "Yes" and press the **[OK]** key.

```
Program? /OK
[Add] Delete Exit
```

8 Press **⏪** or **⏩** to select "Delete" and press the **[OK]** key.

```
Select Destination
with
```

9 Press **⏪** or **⏩** to display the destination you want to delete.

```
Delete? /OK
001 ABC COMPANY
```

**To change and delete Quick Dials programmed as groups:**

To store an entire group under a different Quick Dial key, or to delete the group from the Quick Dial key altogether, perform the following procedure:

- ① Press the **[User Tools]** key.
- ② Confirm that "1. Program / Delete" is displayed.
- ③ Press the **[OK]** key, and then press **⏪** or **⏩** to display "5. Prog. Group Dial".
- ④ Press the **[OK]** key.
- ⑤ Enter the group number (1 to 7).
- ⑥ Press the **[OK]** key.
- ⑦ Press **⏪** or **⏩** to select "No", and then press the **[OK]** key.
- ⑧ Press the **[OK]** key.
- ⑨ If you want to change the Quick Dial key, press "Yes", and if you want to delete the Quick Dial key, press "No".
- ⑩ Press the **[OK]** key.
If you selected "No" in step ⑨, the Quick Dial key is deleted. Go to step ⑬.
- ⑪ If you want to change the Quick Dial key, press the new Quick Dial key.
- ⑫ Press the **[OK]** key.
The Quick Dial key is changed.
- ⑬ Press the **[User Tools]** key to return to standby mode.

Entering Characters

Use the number keys to enter numbers. Use Quick Dial keys for entering letters, and the **[Symbols]** key for entering symbols.

If at any time you make a mistake when entering a character or digit, press the **[Clear]** key to delete it. To correct a character or number already entered, use \leftarrow or \rightarrow to reach the mistake, enter the new character, and then press the **[Clear]** key to delete the mistaken character.

3

Note

- When Mail Address input is selected, you can enter the "@" symbol and periods in E-mail addresses with the Quick Dial keys. See Chapter 1, "Operation Panel" in the NIC FAX KIT manual.
- You can switch the character input mode between uppercase letters (ABC) and lowercase letters (abc) by pressing the **[ABC/abc]** key. You can input symbols regardless of this mode.
- With the QWERTY keyboard layout, the **[ABC/abc]** key is key 21, and with the ABC layout it is key 29. The **[Symbol]** key is key 30 with both layouts.

Entering Symbols

- 1** Press the **[Symbol]** key.
- 2** Press \leftarrow or \rightarrow to scroll through the symbols.

Note

- You can enter the following symbols: - _ (space) . , () / @ & \$! " ' # * % + : ; < = > ? ^ [] \ ` { | } ~

- 3** Press the **[OK]** key.

Wild Card

Using wild cards, you can greatly enhance the effectiveness of the following features:

- Authorized Reception
- Memory Lock
- Multi-copy Reception
- Specified Cassette Selection
- Forwarding

In each of these features, you have to store the Own Name or Own Fax Number setting of the various terminals that you normally receive fax documents from. Then, when your machine detects an incoming call, it checks the Own Name or Own Fax Number setting of the other terminal and acts accordingly.

When you use Own Name with these features, you can program wild cards to greatly expand the number of terminals that you can specify.

For example, if you wish to accept documents from all 150 branches of XYZ Company (using Authorized Reception), and forward them on to head office (using Forwarding), you do not have to store the Own Name of each branch of XYZ Company. Program "XYZ" as a wild card for each of these functions. If the Own Name settings of all XYZ branches contain "XYZ", incoming documents from those branches will be accepted and sent on to the head office.

 **Note**

- This feature cannot recognize spaces. If you store MAN as a wild card, and a terminal with an Own Name including MANCHESTER, HUMAN, or HUMANE calls you, your machine will recognize MAN as a wild card and accept and/or forward the document.

 **Reference**

See Chapter 7, "Authorized Reception" in the Advanced Features manual.

See Chapter 7, "Forwarding" in the Advanced Features manual.

Own Name and Own Fax Number, see P.23 "Initial Settings and Adjustments".

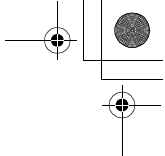
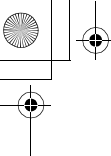

Setup

3

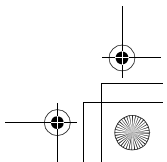
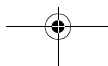
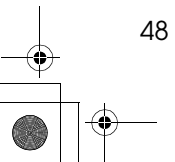
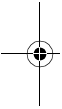

4. Troubleshooting

Loading Paper in the Main Paper Cassette

The following procedure describes how to load paper in the main paper cassette.

Important

- When loading paper, be careful not to pinch your fingers inside the machine.
- Before loading paper, make sure that the machine is not outputting a copy or received document.

Reference

For paper sizes, paper direction, and the number of sheets that can be loaded in the main paper cassette, see Chapter 11, "Document and Paper Specifications" in the Advanced Features manual.

For information on how to load the optional bypass feeder, see Chapter 9, "Loading Paper in the Optional Bypass Feeder" in the Advanced Features manual.

- 1** Pull out the main paper cassette and place it on a flat surface.

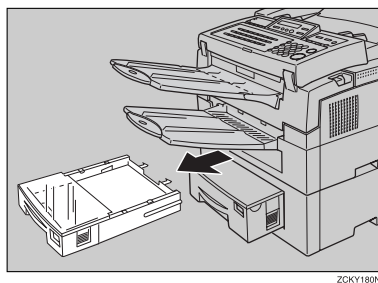

Note

- Remove any paper that may have dropped inside the machine in the area vacated by the paper cassette.

- 2** Lift up the cassette cover and remove it.

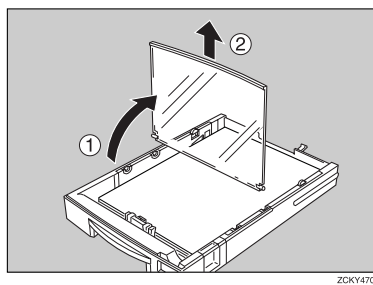

- 3** Remove any remaining paper.

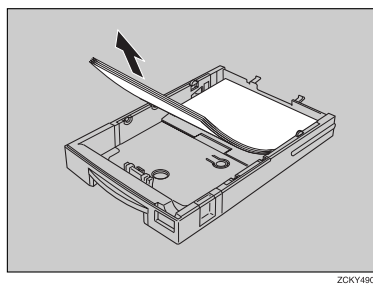

- 4** If the metal base plate is raised, push it firmly down until it locks into place.

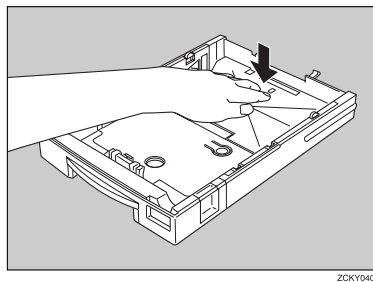

Troubleshooting

- 5** Prepare a stack of blank paper. For smoother operation, square the edges by tapping the paper stack on the bench.

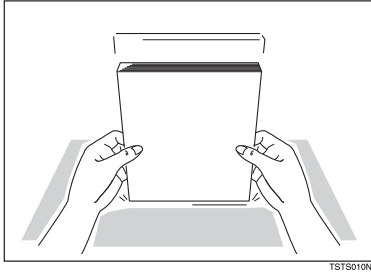

4

- 6** Load the paper into the cassette.

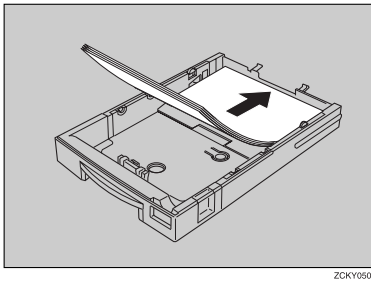

Note

- Do not load paper above the paper level marks inside the cassette.

- 7** Replace the cassette cover.

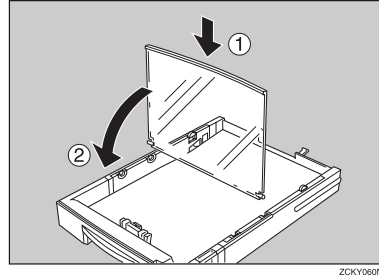

Note

- The frosted side of the cover must be faceup when closed.

- 8** Replace the cassette. Push it in firmly until it locks into place.

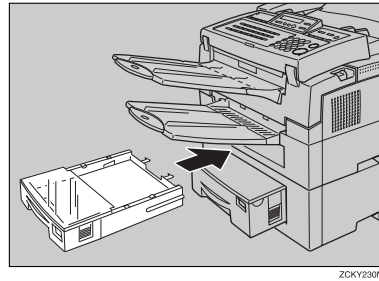

Note

- If you cannot close the cassette, check that the metal base plate is not raised.

Adjusting the Volume and Sounds the Machine Makes

You can change the beeper (monitor) volume for the following features:

On Hook	The sound that indicates on hook dialing.
Transmission	The sound that indicates transmission.
Reception	The sound that indicates reception.
Dialing	The sound that indicates dialing.
Key Tone	The sound that indicates a key being pressed.
Alarm	The sound that indicates something has gone wrong.

4

The following procedure describes how to adjust the volume for the above features.

Note

- Make sure that the machine is in standby mode.

1 Press the **[User Tools]** key.

```
User Tools Main Menu
1.Program / Delete
```

2 Press **⏪** or **⏩** to display "3. Setup".

```
User Tools Main Menu
3.Setup
```

3 Press the **[OK]** key.

Confirm that "1. Monitor Volume" is displayed.

```
Setup:
1.Monitor Volume
```

4 Press the **[OK]** key.

```
Monitor Volume:
1.On Hook
```

5 Press **⏪** or **⏩** to select the item you want to adjust, and then press the **[OK]** key.

```
On Hook:
Low---|---High
```

Troubleshooting

6 Press **←** or **→** to adjust the volume.

```
On Hook:      ←/OK
LOW-----↑-High
```

7 Press the **[OK]** key.

The volume is adjusted.

```
Monitor Volume:
1.On Hook      →
```

If you want to adjust another item, repeat steps **6** to **7**.

4

8 Press the **[User Tools]** key to return to standby mode.

If an Indicator Lights on the Operation Panel

Whenever you see the file receive indicator or the alarm indicator light, always read the document in the control panel display.

◆ **The Receive File indicator is lit:**

You have received a fax document which is now stored in the machine. See Chapter 4, "Printing Documents That Have Been Received into Memory (Substitute Reception)" in the Advanced Features manual.

◆ **The Communicating indicator is lit.**

You are sending or receiving a fax. See P.5 "Operation Panel".

◆ **The Alarm indicator flashes.**

An error has occurred. Read the message in the display and take appropriate action. See P.5 "Operation Panel".

Communication Problems

If "Transmission Failed / OK" appears in the display: Press the **[OK]** key.

Causes:



```
Transmission Failed
                    /OK
```

4

- A poor line caused the communication to fail.
- The line is noisy. Try to retransmit.
- The other machine is out of order. Ask the other party to check their machine.

Clearing a Document Jam

When an original is jammed, "Clear Misfed Orig. Storing Stopped, / OK" is displayed. Perform the following procedure to solve the problem.

Note

- If copies, documents, or prints are jammed, follow the procedure on the next page.

- 1** Open the operation panel to an angle of about 45°.

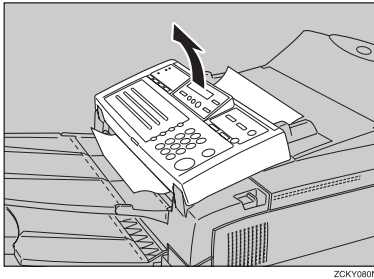

ZCKY090N

- 2** Remove the original.

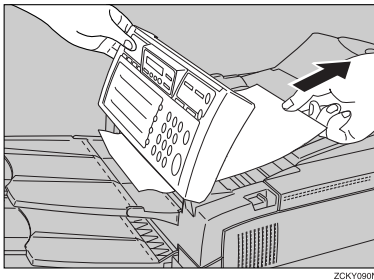

ZCKY090N

Important

- Do not pull out the document without opening the operation panel, or you will damage the scanning mechanism.

- 3** Close the operation panel completely. Make sure that it clicks and locks into place.

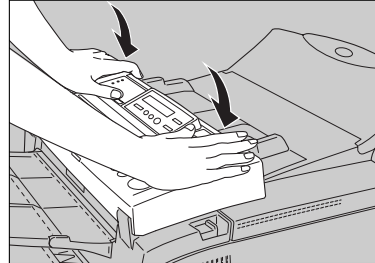

ZCKY100N

4

Troubleshooting

Clearing a Copy, Fax, or Print Jam

When "Clear Misfed Paper" is displayed, follow the procedure below to solve the problem.

To clear original jams, see the previous page.

Important

- The transfer roller and surrounding area inside the machine becomes hot during printing. To avoid injury when removing paper jams, do not touch any parts other than those specified in this manual.

4

Note

- If paper jams occur in the optional second paper cassette or optional bypass feeder. (See chapter 8, "Clearing a Copy Fax, or Print Jam" in the Advanced Features manual.).

Print Delivery Tray

- 1** Fold the tray up (1) and remove any jammed paper (2).

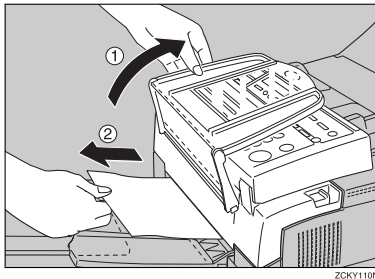

ZCKY110N

Inside the Machine

- 1** Pull the front cover release lever towards you and open the front cover.

Note

- If you do not pull the lever, only the operation panel will open.

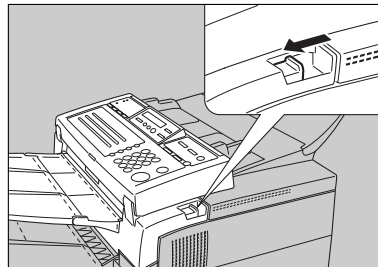

ZCKY120N

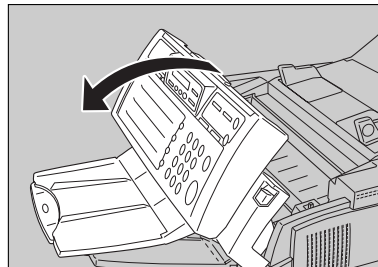

ZCKY600N

- 2** Remove the toner cassette.

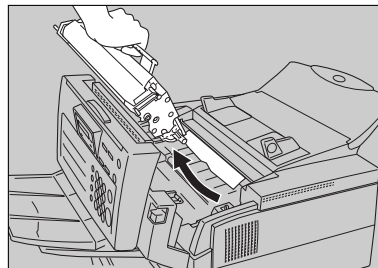

ZCKY130N

- 3** Remove any jammed paper underneath.

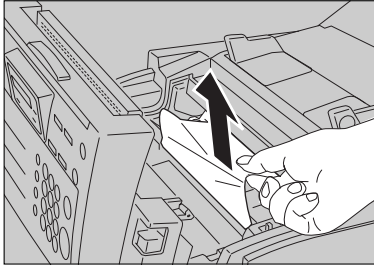

- 6** Push the front cover closed until you hear it lock into place.

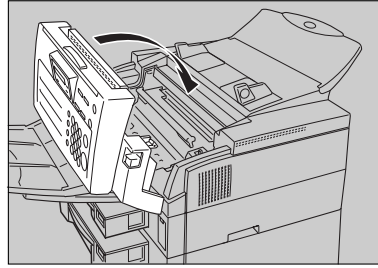

- 4** Replace the toner cassette by aligning it with the guide rails and sliding it into place.

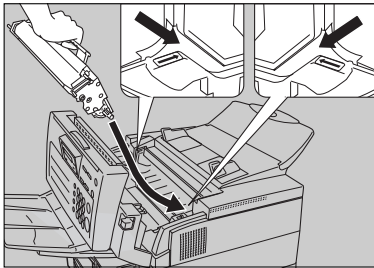

- 5** Confirm that the toner cassette is locked into position.

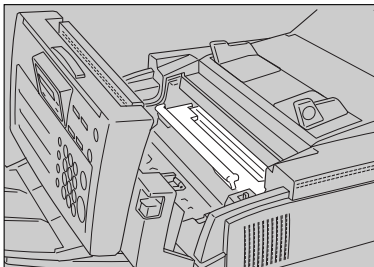

Cassette Entrance

4

- 1** Remove the main paper cassette and place it on a flat surface.

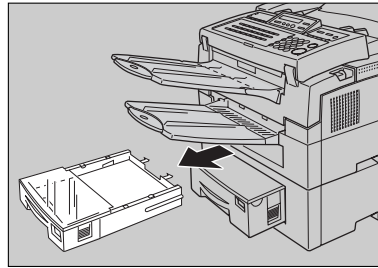

- 2** Lift the document delivery table and remove any jammed paper from inside the machine.

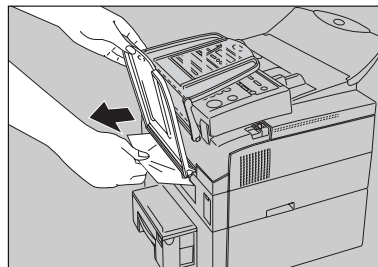

Troubleshooting

- Return the document delivery table to its original position.

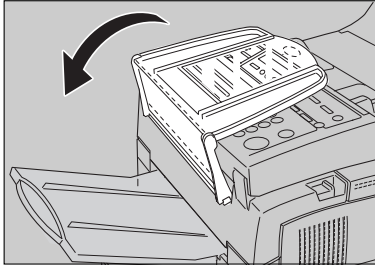

ZCKY210N

4

- Push down on the paper until you hear the base plate lock into place.

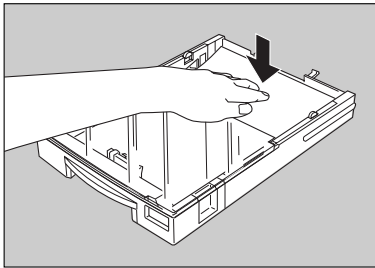

ZCKY900N

- Replace the main paper cassette.

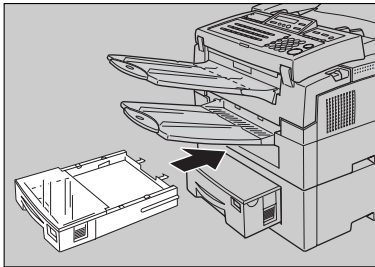

ZCKY230N

Upper Rear Unit

- Pull the document table toward the front of the machine.

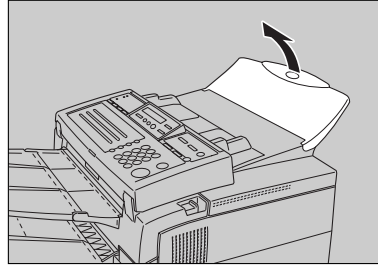

ZCKY240N

- Open the lower rear cover and then upper rear cover as shown in the illustration.

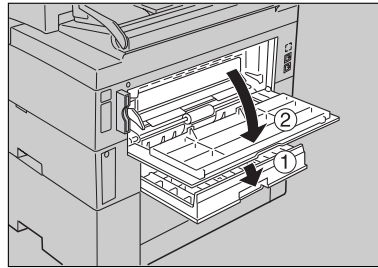

ZCKY250N

- Remove any jammed paper.

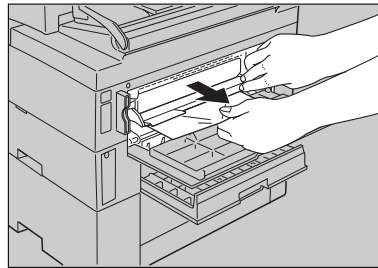

ZCKY260N

- 4** Close the upper rear cover and then the lower rear cover as shown in the illustration.

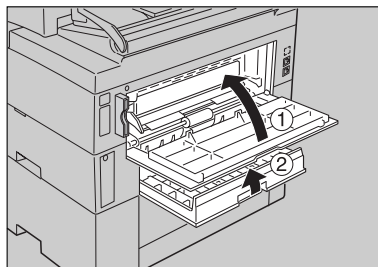

ZOKY270N

- 5** Return the document table to its original position.

4

Error Messages

The following messages may appear while you are operating or programming the machine.

Reference

See Chapter 6, "Error Messages" in the NIC FAX KIT manual for network errors that may occur when using Internet Fax.

Message	Problem/Solution
No Files Exist	No polling reception operations have been programmed. There are no documents in memory waiting for transmission. Incorrect file number. Check the file number and try again.
Cannot Combine: (currently selected function)	Appears when you attempt to select a function that cannot be used in combination with another currently selected function.
This Key is in Use as a Group Dial	This Quick Dial Key has a Group stored in it.
This Key is in Use as a Program	This Quick Dial Key has a Keystroke Program stored in it.
This Key is in Use as a Quick Dial	This Quick Dial Key has a Quick Dial stored in it.
This Key is Not Programmed	Either: <ul style="list-style-type: none"> This Quick Dial Key does not contain a number. This Quick Dial Key does not contain a Keystroke Program.
This Speed Dial No. is Not Programmed	This Speed Dial number does not contain a number.
This Dest. is Already Selected	Either: <ul style="list-style-type: none"> This number is already included in this Group. The same destination was specified more than once.
Insert Pause "_" After Area Code	You must add a pause after your area code when you input your fax terminal's own telephone number.
Replace Toner	The toner cassette is empty. Install a new cassette.
Clear Misfed Orig.	A document is jammed in the feeder.
Clear Misfed Paper	Paper is jammed in the printer.
Close Front Cover Close Rear Cover	A cover is not closed properly. Check that all covers are closed.
Machine is in Use. Please Wait.	Machine cannot print a list/file, because the plotter is not ready.

Error Messages

Message	Problem/Solution
Call Service.	Machine is out of order. Contact your service representative.
Check Paper Size. Press OK to Correct.	The size of the installed paper does not match the currently selected paper size. Press the [OK] key, and then set the paper size or install the appropriate paper.
This Dial is in Use. Cannot Delete. This Dial is in Use. Cannot Change.	This Quick Dial is being used (such as for a Send Later Transmission).
Some Page(s) are Blank	An almost entirely blank document was scanned. Check your document.
Reset Toner Correctly	The toner cassette is not set correctly.
Toner is Almost Empty	The toner cassette is nearly empty.
Copy Mode Locked	Copy mode is disabled. Enable it with the User Parameters.
Change ADF Pad	Replace the ADF separation pad.

Troubleshooting

Solutions to Common Problems

Problem	Required Action
STANDBY MODE	
Nothing happens when the switch is turned on.	Check the power cord. Is it properly plugged into the outlet? Plug it in firmly.
"Set Orig. / Enter No." is not displayed.	Switch the power on. If the Power indicator does not light, check that the power cord is plugged in. If the Energy Saver indicator lights, press the Energy Saver key.
<div style="background-color: #808080; color: white; padding: 2px 5px; display: inline-block; border-radius: 5px;">4</div> The display does not show the Ready condition, or the machine stops during an operation.	Does "Clear Misfed Orig." or "Clear Misfed Paper" appear in the display? Clear the misfed paper.
	 Reference See P.55 "Clearing a Document Jam", and P.56 "Clearing a Copy, Fax, or Print Jam".
	Does "Load Paper" appear in the display? Load paper into the paper tray. See P.49 "Loading Paper in the Main Paper Cassette".
	Does "Close Front Cover" or "Close Rear Cover" appear in the display? Close all covers.
	Is the Add Toner indicator on? Load a new toner cassette.
TRANSMISSION	
The original is not pulled into the auto document feeder.	You did not feed the document far enough into the feeder. Insert the document into the feeder until it stops. Retransmit.
	Do user maintenance, especially rollers (2) and (6). See the illustration in Chapter 9, "Cleaning the Rollers and Exposure Glass" in the Advanced Features manual.
	The telephone line is disconnected. Check that the line is connected properly.
	The telephone line type setting is incorrect. Check the telephone line type setting.
	The dialed number does not contain a PSTN access code or a pause. Include the outside line access number and a pause before the telephone number.

Problem	Required Action
The original is not pulled into the auto document feeder.	The dialed number did not have enough pauses between the outside line access number and the telephone number. Try adding more pauses after the outside line access number.
Frequent original misfeeds (Multifeeds)	Incorrect positioning of originals. Position the document in the feeder correctly. See P.11 "Memory Transmission".
	Incorrect alignment of originals. Align the edges of the document. See P.10 "Suitable Document Types".
	Curled pages. Flatten the document. See P.10 "Suitable Document Types".
	Incorrect document type. Use a proper document type. See P.10 "Suitable Document Types".
	Mixed document types. The pages must all be of the same type.
	Static electricity on the originals. Shuffle the document. See P.11 "Memory Transmission".
Frequent original misfeeds (Non-feeds)	Do user maintenance, especially rollers (2) and (6). See the illustration in Chapter 9, "Cleaning the Rollers and Exposure Glass" in the Advanced Features manual.
	Copier silicone oil on the originals. Wait a few minutes, then try again.
	Incorrect alignment of originals. Align the edges of the document. See P.11 "Memory Transmission".
	Curled pages Flatten the document. See P.10 "Suitable Document Types".
	Incorrect document type. Use a proper document type. See P.10 "Suitable Document Types".
	More than 50 pages in the feeder. Do not load more than 50 pages in the automatic document feeder at once.
Transmission cannot take place; "Clear Misfed Orig." appears.	Do user maintenance, especially rollers (2) and (6). See the illustration in Chapter 9, "Cleaning the Rollers and Exposure Glass" in the Advanced Features manual.
	The document is jammed in the feeder. Remove the jammed document. See P.55 "Clearing a Document Jam".
	The document may be longer than the maximum limit. Make sure that none of your originals exceed this limit.

Troubleshooting

Problem	Required Action
Transmission cannot take place. Before taking action, wait until the machine is in standby mode, then press the [Stop] key.	The other machine is out of order. Check the error report. Ask the other party to check their machine and correct the fault.
	The line is noisy. Check that the dial tone is sent out. Try to retransmit.
Consistent difficulty in communicating with a particular terminal	There are some bad lines between you and that other terminal. Store that terminal's number as a Quick Dial Key or Speed Dial Code.
Consistent poor image quality when communicating with a particular terminal	Then call a service technician. Inform them of the nature of the problem and give the Quick Dial Key or Speed Dial Code that you stored the number in.
RECEPTION	
The telephone keeps ringing and no fax is printed.	You are in Manual Receive mode. Change to Auto Receive mode. See P.22 "Reception Modes".
	Power is switched off. Switch the power on.
RECEPTION/COPYING	
No printout; the Add Paper indicator is lit.	The cassettes are empty. Add Paper. See P.49 "Loading Paper in the Main Paper Cassette".
No printout; Clear Misfed Paper appears.	The printer has jammed. Clear the jam. See P.56 "Clearing a Copy, Fax, or Print Jam".
Copies are blank.	The original must be placed facedown in the document feeder. Position the original correctly. See P.11 "Memory Transmission".
Copy paper misfeeds occur frequently.	Is the proper paper in the paper cassette? Paper size and weight must be within the standards set for this machine.
	Is folded, wrinkled, damp, or curled paper in the paper cassette? Always use dry, undamaged paper.
	Is the paper set properly in the paper cassette? Always load paper correctly. See P.49 "Loading Paper in the Main Paper Cassette". Make sure that there is not too much paper in the trays; do not fill them up over the load limit mark.

Problem	Required Action
Copy paper misfeeds occur frequently.	Are there any pieces of misfed paper or other foreign objects in the machine? Make sure that the paper path is completely clear of paper and other material after a misfeed.
	Are you copying onto recycled paper? Fan the stack of recycled paper and load it in the paper tray.
Stripes on copies.	The exposure glass is dirty. Clean the exposure glass. See Chapter 9, "Cleaning the Rollers and Exposure Glass" in the Advanced Features manual.
TELEPHONING	
You cannot receive phone calls; the unit only rings once then goes into receive mode.	You are in Auto Receive mode. Change to Manual Receive mode. See P.22 "Reception Modes".
You cannot receive phone calls; the unit does not ring.	The telephone line is not connected. Connect the modular cord.

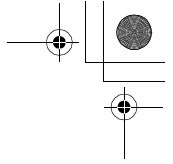
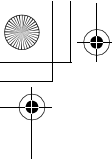

Troubleshooting

4

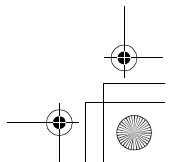
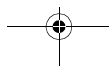
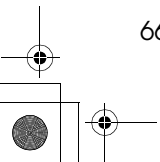
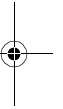
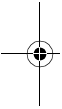

5. Appendix

Options

- ◆ **PAPER FEED UNIT TYPE180 (Second Paper Cassette)**
A second paper feed unit can be added to the base machine.
- ◆ **BYPASS FEEDER TYPE180**
A third paper feed unit can be added to the base machine.
- ◆ **ADF MAINTENANCE KIT TYPE 210**
This is a maintenance kit for the ADF (Auto Document Feeder).
- ◆ **FAX EXPANSION CARD TYPE20**
A 2-Mbyte memory card can be added.
- ◆ **FAX EXPANSION CARD TYPE40**
A 4-Mbyte memory card can be added.
- ◆ **ISDN INTERFACE UNIT TYPE 190 (G4 Unit)**
This allows you to send and receive using the ISDN (Integrated Service Digital Network).
- ◆ **HANDSET TYPE 100**
This allows you to dial fax numbers without having to use the operation panel.
- ◆ **MECHANICAL COUNTER TYPE 210**
This is a tamper-proof mechanical counter whose reading cannot be changed by the user.

INDEX

A

- Add Paper indicator, 5
- Add Toner indicator, 5
- Auto Document Feeder (ADF), 4

C

- Canceling a Memory Transmission, 13
 - Before the start key is pressed*, 13
 - During Transmission*, 13
 - While the document is awaiting transmission*, 14
 - While the document is being scanned in*, 13
- Canceling an Immediate Transmission, 15
 - Before the start key is pressed*, 15
 - While dialing or during transmission*, 15
- [Cancel]** key, 6
- Characters, 46
 - Entering*, 46
- CLEAR COPY, 56
- Clearing a Jam, 56
 - Document*, 55
 - Inside the machine*, 56
- [Clear]** key, 6
- Communication Problems, 54
- Control panel display, 6
- [Copy]** key, 7
- CSI → Own Fax Number, 23

D

- Deleting
 - Quick Dial Numbers*, 30
 - Speed Dial Numbers*, 36
- Dialing, 17
- Document Delivery Tray, 3
- Document Guide, 4
- Document Jam, 55
- Document Table, 4

E

- Editing
 - Fax Numbers*, 27
 - Group*, 40
 - Quick Dial Number*, 29
 - Speed Dial Numbers*, 34
- [Energy Saver/ Clear Modes]** key, 7
- Entering
 - Characters*, 46
 - Symbols*, 46
- Entering Numbers Directly, 17
- Error Messages, 60

F

- Fax Header, 23
- Faxing, 9
- Front Cover, 4
- Front Cover Release Lever, 4

G

- G4 Interface Unit, 4
- [G4]** key, 6
- Group, 20
 - Adding a Fax Number to*, 41
 - Deleting*, 43, 44
 - Deleting a Destination From*, 43
 - Editing*, 40
 - Specifying with Group key*, 21
 - Specifying with Quick Dial*, 20
- Group Name, Editing, 40
- Group of Fax Numbers, Storing, 37

H

- [Help]** key, 6

I

- Immediate Transmission, 9, 14
- Indicators
 - Check Display*, 53
 - Manual Receive*, 22
 - Memory*, 11
 - Receive File*, 53
- Initial Settings, 23
- Introduction, 3

J

[Job Information] key, 6

M

Main Paper Cassette, 3
 Main Switch, 4
 Manual Receive indicator, 22
 Memory Card Cover, 4
[Memory] key, 6
 Memory Transmission, 9, 11

N

Number keys, 7

O

[OK] key, 6
[On Hook Dial] key, 6
 Operation Panel, 4, 5
 Optional Bypass Feeder, 4
 Optional Handset, 4
 Optional Second Paper Cassette, 3
 Own Fax Number (Required by international law), 23
 Own Name, 23

P

Paper, 49
 Loading, 49
 Part Names, 3
[Pause/Redial] key, 6
 Pauses, Entering, 18
 Print Delivery Tray, 3
 Programmed Data
 Deleting, 25
 Storing and Editing, 24
 Programming
 Fax Header, 23
 Fax Numbers, 27
 Group, 37
 Own Fax Number, 23
 Own Name, 23
 Quick Dial Numbers, 27
 Speed Dial Numbers, 33

Q

Quick Dial, 18, 27
 Quick Dial Key Labels, 31
[Quick Dial] keys, 6
 Quick Dial Number
 Deleting, 30
 Editing, 29
 Storing, 27

R

Rear Covers, 4
 Receive File indicator, 5
 Reception Mode
 Auto Receive, 22
 Manual Receive, 22
[Reception Mode] key, 6
 Resolution, 16
[Resolution] key, 5
 RTI → Own Name, 23

S

Scroll Keys, 6
 Sending a Fax, 11
 Solutions to Common Problems, 62
 Speed Dial, 19, 33
 Speed Dial Numbers
 Deleting, 36
 Editing, 34
 Storing, 33
[Speed Dial/Tel Directory] key, 7
[Start] key, 7
 Status Indicators, 6
[Stop] key, 7
 Storing and Editing Fax Numbers, 27
 Suitable Document Types, 10
 Switching to Tone Signals, 18
 Symbols, 8
 Entering, 46

T

- [*]** (Tone) key, 7
- Transmission
 - Immediate*, 14
 - Memory*, 11
- Transmission Modes, 9
- [Trans. Option]** key, 6
- Troubleshooting, 49
 - Clearing a Copy, Fax or Print Jam*, 56
 - Clearing a Document Jam*, 55
 - Common Problems*, 62
 - Communication Problems*, 54
 - Error Messages*, 60
 - Indicators*, 53
 - Loading Paper*, 49
 - Volume Adjustment*, 51
- TTI → Fax Header, 23

U

- User Function keys, 5
- [User Tools]** key, 6

V

- Ventilation Port, 4
- Volume Control, 51

W

- While the document is being scanned in, 13
- Wild Cards, 46

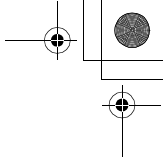
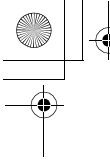

MEMO

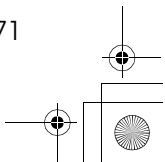
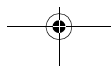
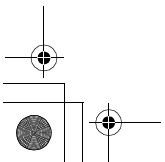
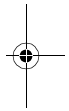
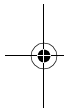

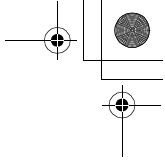
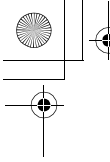

MEMO

